

RADIO CRAFT

THOUSAND-MILE
LIFEBOAT RADIO
SEE PAGE 626

ALEX
SCHOMBURG

JULY
1945

25¢
CANADA 30¢

RADIO-ELECTRONICS IN ALL ITS PHASES

you can't *put the squeeze*
on SEALDTITE
CAPACITORS



Just try it . . . Take a genuine "SealDtite" capacitor and try to *squeeze* it. No results. You'll find it has no soft spots, which in ordinary tubulars provide room for moisture, the capacitor's worst enemy, because the Solar capacitor has an internal winding of high quality paper and foil, skillfully *molded* into *solid* plastic.

No moisture can penetrate this protective case and its substantial construction permits rough handling, assures long and *reliable* service. Use "SealDtite" capacitors. Send for your copy of Catalog V-4. Any Climate—Any Atmosphere— Any Service.



 BAYONNE PLANT 
WEST N.Y. PLANT

A TOTAL OF EIGHT ARMY-NAVY
EXCELLENCE AWARDS

SOLAR CAPACITOR SALES CORP.
285 MADISON AVENUE, NEW YORK CITY

 7567

Get this FREE Lesson in Radio

Gives you a real start toward understanding these subjects

With 31 Photos, Sketches, Radio Drawings

How superheterodyne circuits work
How to remove tubes, tube shields
Three reasons why Radio tubes fail
Electrodynamic loudspeaker:
How it works
Replacing damaged cone
Recentring voice coil
Remedies for open field coil
Output transformer construction, repair
Gang Tuning condenser:
Construction of rotor, stator
How capacity varies

Restranging dial cord
Straightening bent rotor plates
I.F. transformers:
What they do, repair hints
How to locate defective soldered joints
Inside story of carbon resistors
Paper, electrolytic, mica, trimmer
condensers
How condensers become shorted, leaky
Antenna, oscillator coil facts
Power transformer:
Construction, possible troubles

Installing power cord
Troubles of combination volume
control, on-off switch
Tone controls
Dial lamp connections
Receiver servicing technique:
Checking performance
Testing tubes
Circuit disturbance test
Isolating defective stage
Locating defective part

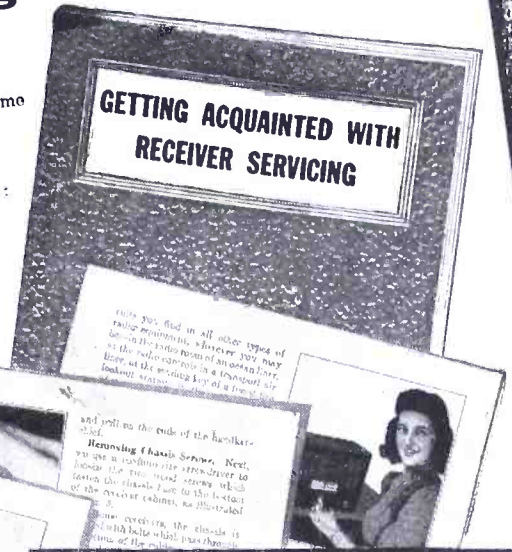

See For Yourself How I Train You at Home to BE A RADIO TECHNICIAN

I want to give every man who's interested in Radio, either professionally or as a hobby, a copy of my Lesson, "Getting Acquainted with Receiver Servicing"—absolutely FREE! It's a valuable lesson. Study it—keep it—use it—without obligation! And with it I'll send my 64-page, illustrated book, "Win Rich Rewards in Radio," FREE. It describes many fascinating jobs in Radio, tells how N.R.I. trains you at home in spare time, how you get practical experience with SIX KITS OF RADIO PARTS I send.

The "Sample" Lesson will show you why the easy-to-grasp lessons of the N.R.I. Course have paved the way to good pay for hundreds of other men. I will send it to you without obligation. MAIL THE COUPON!

I Trained These Men

Has Own Radio Shop
"I made \$12 a week in a store. Now I own my repair shop. Often clear \$35 to \$45 week."
—Frederick Bell, 76 Golf Ave., St. Johns, Newfoundland.



\$600 a Year in Spare Time
"Doing spare time radio work. I earned money in radio before graduating. Profit last 12 months was \$600."
—E. F. Boettcher, Marinette, Wis.



In Aircraft Radio
"I do radio work at Greenwood Army Air Field, and operate a radio shop in spare time."
—James L. Boyett, P.O. Box 218, Greenwood, Miss.



Network Engineer
"I began N.R.I. training when I was 16. Am now transmitter engineer for one of the networks."
—Theodore Campbell, Johnstown, Pa.



My Radio Course Includes TELEVISION • ELECTRONICS FREQUENCY MODULATION

Future for Trained Men is Bright in Radio, Television, Electronics

The Radio Repair business is booming NOW. There is good money fixing Radios in your spare time or own full time business. And trained Radio Technicians also find wide-open opportunities in Police, Aviation and Marine Radio, in Broadcasting, Radio Manufacturing, Public Address work, etc. Think of the boom coming when new Radios can be made! And think of even greater opportunities when Television, FM, Electronics, can be offered to the public! Get into Radio NOW.

Many Beginners Soon Make \$5, \$10 a Week EXTRA in Spare Time

The day you enroll I start sending EXTRA MONEY JOB SHEETS to help you make EXTRA money fixing Radios in spare time while learning. You LEARN Radio principles from my easy-to-grasp Lessons—PRACTICE what you learn by building real Radio Circuits with the six kits of Radio parts I send—USE your knowledge to make extra money while getting ready for a good full time Radio job.

Find Out What N.R.I. Can Do for YOU

MAIL COUPON for Sample Lesson and FREE 64-page book. It's packed with facts about opportunities for you. Read the details about my Course. Read letters from men I trained, telling what they are doing, earning. Just MAIL COUPON in an envelope or paste it on a penny postal.—J. E. SMITH, President, Dept. 5GX, National Radio Institute, Pioneer Home Study Radio School, Washington 9, D. C.

OUR 31ST YEAR OF TRAINING MEN FOR SUCCESS IN RADIO

GOOD FOR BOTH 64 PAGE BOOK FREE

Mr. J. E. Smith, President, Dept. 5GX NATIONAL RADIO INSTITUTE, Washington 9, D. C.

Mail me FREE without obligation, Sample Lesson and 64-page book, "Win Rich Rewards in Radio." (No salesman will call. Please write plainly.)

Name
Address
City Zone State AFR

You Build These and Many Other Radio Circuits with 6 Kits of Parts I Supply

By the time you've conducted 60 sets of Experiments, made hundreds of measurements and adjustments, you'll have valuable PRACTICAL Radio experience.

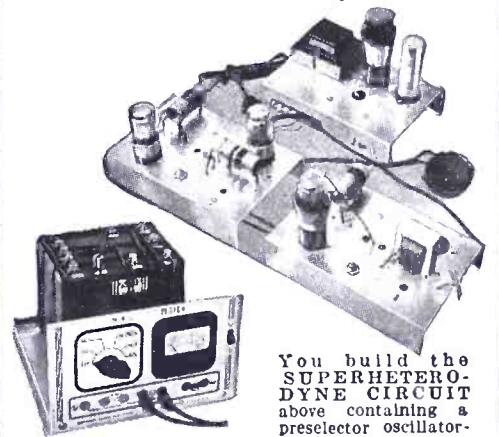

You build MEASURING INSTRUMENT above early in Course, useful for Radio work to pick up EXTRA spare time money. It is a vacuum tube multimeter, measures A.C., D.C., R.F. volts, D.C. currents, resistance, receiver output.

You build the SUPERHETERODYNE CIRCUIT above containing a preselector oscillator-mixer-first detector, i.f. stage, diode-detector-a.v.c. stage and audio stage. It will bring in local and distant stations. Get the thrill of learning at home evenings in spare time while you put the set through fascinating tests!

Building the A. M. SIGNAL GENERATOR at right will give you valuable experience. Provides amplitude-modulated signals for test and experimental purposes.

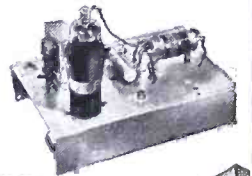

Another
**N. U. SERVICE
 FOR SERVICE
 MEN**



UP-TO-THE-MINUTE TECHNICAL BULLETINS

Now available from coast to coast at National Union Distributors, is this big book of N. U. Service Engineering Bulletins. It is loaded with timely technical tips, troubleshooting short cuts and service suggestions, prepared by top notch N. U. engineers with all the newest radio facts at their finger tips. And all so easy to get at—arranged on handy separate bulletin sheets covering one subject at a time.

A ready reference file of N. U. Service Engineering Bulletins is now on hand at your National Union Distributor. You are invited to refer to it regularly. Bulletins in which you are particularly interested, may be obtained FREE from your N. U. Distributor. *National Union Radio Corporation, Newark 2, N. J.*

Typical Bulletin subject matter

- N. U. 7A4 as a high frequency oscillator
- 3B 7/1291 Ultra high frequency double triode
- 35Z5 filament burnouts
- A simple Loktal to Octal adapter
- Tube substitution data for 25B5
- Replacements for special purpose tubes

After the War, MORE than Before!

**NATIONAL UNION
 RADIO AND ELECTRON TUBES**

Transmitting, Cathode Ray, Receiving, Special Purpose Tubes • Condensers • Volume Controls • Photo Electric Cells • Panel Lamps • Flashlight Bulbs



I'LL SHOW YOU HOW TO SUCCEED IN RADIO

Here's the right training for Big Post-War Pay!



F. L. Sprayberry, one of the country's foremost Radio Teachers.

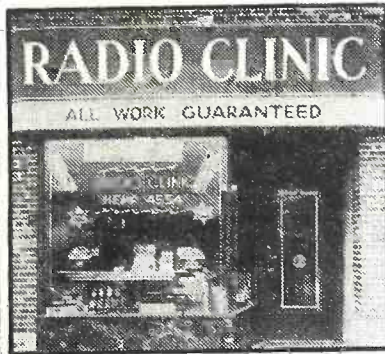

A RADIO SERVICE BUSINESS OF YOUR OWN

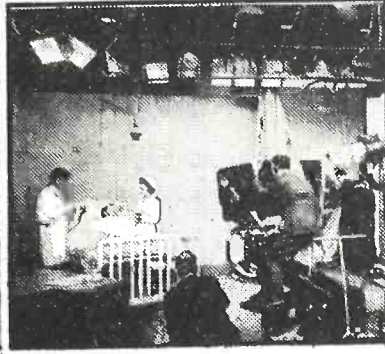

A GOOD JOB IN RADIO & TELEVISION BROADCASTING



RADIO-ELECTRONIC SERVICE ENGINEER

BE A RADIO-ELECTRONICIAN



I SUPPLY A FULL RADIO SET for practical easy LEARNING

NOW! YOU CAN PREPARE AT HOME IN YOUR SPARE TIME FOR THE AMAZING OPPORTUNITIES AHEAD IN RADIO — ELECTRONICS — TELEVISION

The offer I make you here is the opportunity of a lifetime. It's your big chance to get ready for a wonderful future in the swiftly expanding field of Radio-Electronics INCLUDING Radio, Television, Frequency Modulation and Industrial Electronics. Be wise! NOW'S the time to start. Opportunities ahead are tremendous! No previous experience is necessary. The Sprayberry Course starts right at the beginning of Radio. You can't get lost. It gets the various subjects across in such a clear, simple way that you understand and remember. And, you can master my entire course

in your spare time. It will not interfere in any way with your present duties. Along with your Training, you will receive my famous BUSINESS BUILDERS which will show you how to make some nice profits while learning.

Prepares You for a Business of Your Own or Good Radio Job

My training will give you the broad, fundamental principles so necessary as a background, no matter which branch of Radio you wish to specialize in. I make it easy for you to learn Radio Set Repair and Installation Work. I teach you how to install and repair Electronic Equipment. In fact, you'll be a fully qualified RADIO-ELECTRONICIAN, equipped with the skill and knowledge to perform efficiently and to make a wonderful success of yourself.

Just Out! FREE!

"How to Read Radio Diagrams and Symbols"

... a valuable new book which explains in simple English how to read and understand any Radio Set Diagram. Provides the quick key to analyzing any Radio circuit. Includes translations of all Radio symbols. Send for this FREE book now, and along with it I will send you another big FREE book describing my Radio-Electronic training.

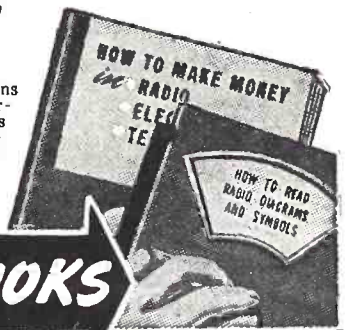

GET FREE BOOKS

SPRAYBERRY TRAINING GIVES YOU BOTH TECHNICAL KNOWLEDGE • SKILLED HANDS

There's only one right way to learn Radio Electronics. You must get it through simplified lesson study combined with actual "shop" practice under the personal guidance of a qualified Radio Teacher. It's exactly this way that Sprayberry trains you... supplying real Radio parts for learn-by-doing experience right at home. Thus, you learn faster, your understanding is clear-cut, you acquire the practical "know how" essential to a good-paying Radio job or a Radio business of your own.

I'll Show You a New, Fast Way to Test Radio Sets Without Mfg. Equipment

The very same Radio Parts I supply with your Course for gaining pre-experience in Radio Repair work may be adapted through an exclusive Sprayberry wiring procedure to serve for complete, fast, accurate Radio Receiver troubleshooting. Thus, under Sprayberry meth-

ods, you do not have one cent of outlay for manufactured Test Equipment which is not only expensive but scarce.

Read What Graduate Says "One Job Nets About \$26.00"

"Since last week I fixed 7 radios, all good-paying jobs and right now I am working on an amplifier system. This job alone will net me about \$26.00. As long as my work keeps coming in this way, I have only one word to say and that is, 'Thanks to my Sprayberry training' and I am not afraid to boast about it."—ADRIEN BENJAMIN, North Grosvenordale, Conn.

DON'T PUT IT OFF!

Get the facts about my training—now! Take the first important step toward the money-making future of your dreams. All features are fully explained in my big, illustrated FREE Catalog which comes to you along with another valuable FREE book you'll be glad to own. Mail Coupon AT ONCE!

SPRAYBERRY ACADEMY OF RADIO

F. L. Sprayberry, Pres.
Room 2075
Pueblo, Colorado

Please rush my FREE copies of "HOW TO MAKE MONEY IN RADIO, ELECTRONICS and TELEVISION," and "HOW TO READ RADIO DIAGRAMS and SYMBOLS."

Name Age

Address

City State

Tear off this coupon, mail in envelope or paste on penny postcard.

RADIO CRAFT

AND POPULAR ELECTRONICS

Incorporating
SHORT WAVE CRAFT TELEVISION NEWS
RADIO & TELEVISION



HUGO GERNSBACK, *Editor-in-Chief*
FRED SHUNAMAN, *Associate Editor*
I. QUEEN, *Editorial Associate*
ELMER FULLER, *Shortwave Editor*
A. PASCALE, *Production Manager*
G. ALIQUO, *Circulation Manager*
JOHN J. LAMSON, *Advertising Director*
ALFRED STERN, *Promotion Manager*

IN THE NEXT ISSUE

New Radio Receiver Circuits
Effects of Audio Feedback
Using Voltage Measurements
Simple Low-Volt-Ohmmeter

Published by Radcraft Publications, Inc.
Publication Office: 29 Worthington Street,
Springfield 3, Mass.
Editorial and Advertising Offices: 25 West
Broadway, Tel. RE2-9690, New York 7, N. Y.
Chicago Advertising Office: Radio-Craft, 308
W. Washington Street, Suite 1413, Chicago 6,
Ill. Tel. Randolph 7363.
Cleveland Advertising Office: 405 Erie Bldg.,
Cleveland, Ohio. Burdette Phillips, Manager.
Tel. Main 9645.
Los Angeles Advertising Office: 606 South
Hill Street, Los Angeles 14, Calif. Ralph W.
Harker, Manager.
San Francisco Advertising Office: 582 Market
St., San Francisco 4, Calif. Ralph W. Harker,
Manager. Tel. Garfield 2481.
RADIO-CRAFT is published monthly on the
25th of the month preceding that of date.
Subscription rates: United States and pos-
sessions, Mexico, Central and South American
countries, \$2.50 a year, \$4.00 for two years,
\$6.00 for three years. Canada, \$3.00 a
year, \$5.00 for two years, \$7.50 for three
years. All other foreign countries, \$3.25 a year,
\$5.50 for two years, \$8.25 for three years.
Special rates for members of the Armed Forces
in U. S., or those addressed by A.P.O. or F.R.O.
mail, \$2.00. Entered at the post office at
Springfield as second-class matter under the
Act of March 3, 1879. All communications
about subscriptions should be addressed to:
Circulation Manager, Radio-Craft, 29 Worthing-
ton St., Springfield 3, Mass.

Notice of CHANGE of ADDRESS should
reach us at least one month in advance. When
ordering a change, please furnish an address
stencil impression from a recent wrapper if
you can. Address changes cannot be made
without the old address as well as the new.

Foreign Agents

London—Atlas Publishing and Distributing
Co., Ltd., 18 Bride Lane, Fleet St., London,
E.C. 4.

Melbourne—McGill's Agency, 179 Elizabeth
St., Australia.

Text and illustrations of this magazine are
copyright and must not be reproduced without
permission of the copyright owners.
Copyright, 1945, Radcraft Publications, Inc.

Contents July, 1945 Volume XVI, No. 10

Editorial: Radio Can Enforce Peace.....	by Hugo Gernsback	621
Radio-Electronics Monthly Review.....		622

ELECTRONICS

Microwaves, Part I.....	by Captain Eugene F. Skinner	624
Yesterday's Circuits.....	by J. W. Straede	630
Parasitic Oscillations, Part I.....	by Dean Stockett Edmonds, Jr.	631

WAR-TIME RADIO

New Lifeboat Radio.....	by Charles J. Pannill	626
Biggest "Portable" Radio.....		636
Battle Radio Tricks.....		638

RADIO TRAINING

Oscilloscopes for Trainees.....	by "Scotty" Keillor	633
Broadcast Equipment, Part X.....	by Don C. Hoefler	634
Radio Filter Circuits.....	by John Kearney	642

TEST INSTRUMENTS

A "Jewell" Ohmmeter.....	by R. S. Havenhill	627
An Electronic Omnicheker, Part II.....	by Robert E. Altomare	632

SERVICING

Tube Replacements, Part I.....	by I. Queen	625
Radio Repair in Bed.....	by Ruby Moore Huff	629
Repairs with Resistors.....	by Jack King	637
A Pair of Useful Circuits.....	by Charles McCleskey, Jr.	666

CONSTRUCTION

Work Bench for the Apartment.....	by Samuel Cohen	658
Power Supply Stabilizing Unit.....	by E. A. Hanney	661
Remote Control for Your Receiver.....	by Edwin Bohr	669

SOUND

Midget Amplifier.....	by W. A. Rievely	640
-----------------------	------------------	-----

DEPARTMENTS

World-Wide Station List.....	by Elmer R. Fuller	644
New Radio-Electronic Devices.....		646
Radio-Electronic Circuits.....		648
Try This One!.....		650
Progress in Invention.....	by I. Queen	654
Communications.....		672
Available Radio-Electronic Literature.....		675



ON THE COVER

A new lifeboat radio with provision for long and short wave transmission and reception, as well as a number of other improvements on older emergency radios, is the subject of our cover this month. A mechanical generator instead of the batteries heretofore used adapts the transmitter to situations where seamen may spend days or even weeks adrift.

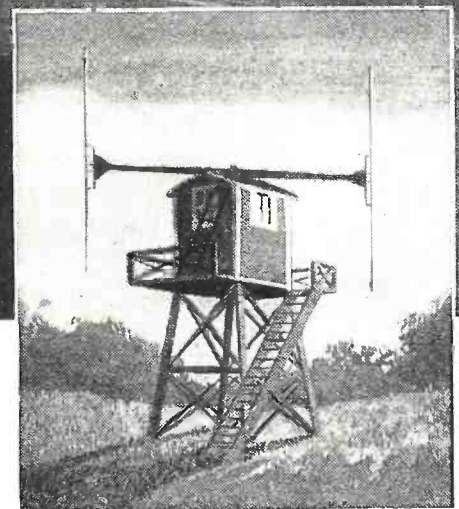
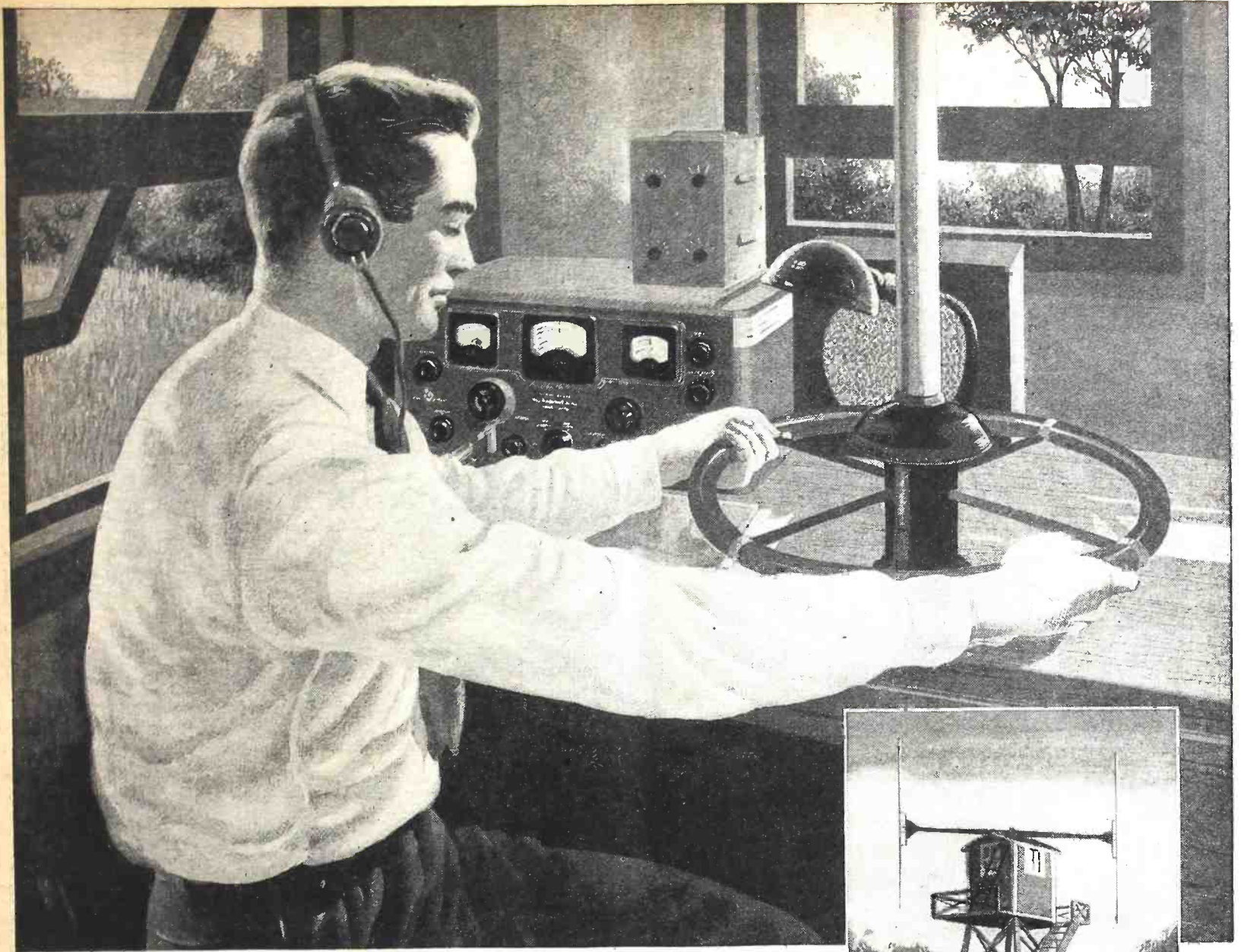

NEW DIRECTIONS...

New directions in radio will be charted by Hallicrafters

The radio amateur has distinguished himself outstandingly in the service of his country in time of war. One of the most interesting and valuable contributions the ham has been able to make is in the ranks of the RID — Radio Intelligence Division of the Federal Communications Commission. RID polices the airways, tracks down illegal radio stations, traps enemy spies. About 70% of the big RID staff are licensed amateur radio operators. Above you see a sketch of a typical ham in employment of RID taking bearings on a radio signal.

For dependable continuous reception, selectivity and stability on a great range of frequencies, the amateur who must be sure of results, picks Hallicrafters equipment. Hallicrafters sets have been developed in the great testing grounds of amateur radio. When the time comes Hallicrafters will be ready with a full line of HF, VHF, and UHF communications equipment, designed specifically for the exacting amateur — and for all others who need the best and the latest combined in the "radio man's radio."



This is the famous Model SX-28A communications receiver. 15 tubes including rectifier. Covers all frequencies from 550 kc to 42 Mc continuous in six bands including standard broadcast band.



BUY A WAR BOND TODAY!

hallicrafters RADIO

COPYRIGHT 1945 THE HALLICRAFTERS CO.

THE HALLICRAFTERS CO., MANUFACTURERS OF RADIO AND ELECTRONIC EQUIPMENT • CHICAGO 16, U. S. A.
RADIO-CRAFT for JULY, 1945

IT'S FUN to live and work in MT. CARMEL, ILL.

Johnny Beauchamp, a supervisor at the Meissner factory in Mt. Carmel, is typical of Meissner's *precision-el*. The camera has recorded Johnny's day . . . a combination of work and play that's a big reason for the high quality you'll find in Meissner products—"precision-built by *precision-el*."



Here's Johnny at work. He's "tops" with subordinates because he's never too busy to give the other fellow a "lift" . . . help make the job easier.



A five-minute walk at noon takes Johnny home for lunch. Usually Connie Sue, his 6-year-old daughter, meets him at the corner. Johnny owns his own bungalow in this attractive section of Mt. Carmel.



There's a smile on his face as he leaves the factory at 4 p. m., but smiles are the rule, *precision-el* . . . ten



minutes later he's ready to apply Meissner precision to the golf game that has won him several trophies.



Flying is another of Johnny's hobbies. He and other members of Meissner's *precision-el* have organized the Mt. Carmel Flying Club, built a hangar, laid out the field. Here a group listens to a student being briefed before the takeoff.



Like most fathers, Johnny finds the baby more interesting than a tender morsel of chicken. After dinner, Johnny may go back to the plant to work out the following day's schedule.

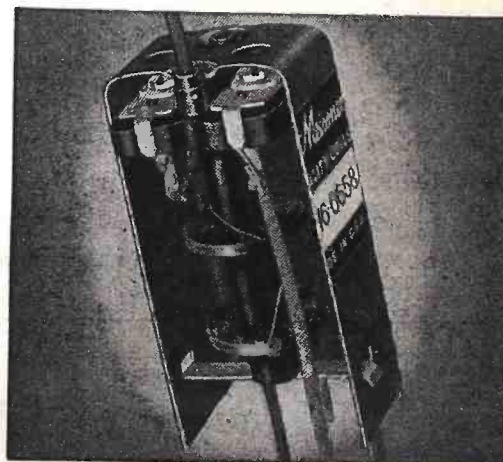

"Step Up" Old Receivers!

These Meissner Ferrocart I. F. input and output transformers are getting top results in stepping up performance of old worn receivers. Special powdered iron core permits higher "Q" with a resultant increase in selectivity and gain, now available for frequency range 127-206. Ask for numbers 16-5728 input, 16-5730 output. List \$2.20 each.



MEISSNER

MANUFACTURING COMPANY • MT. CARMEL, ILL.

ADVANCED ELECTRONIC RESEARCH AND MANUFACTURE

Export Division: 25 Warren St., New York; Cable: Simontrice

Get into the **GOOD PAY** **BIG** **OPPORTUNITY** **FIELD OF ...** **RADIO** **ELECTRONICS**



A "LEARN-BY-DOING" EXPERIMENTS

YOU MAKE 133 FASCINATING EXPERIMENTS WITH THE USE OF 8 BIG KITS OF RADIO PARTS AND ASSEMBLIES

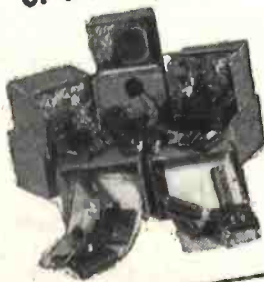

Build modern Radio Receiving Circuits that operate, right in your own "Home Laboratory." Build Electric Eye Devices, an Aviation Band Circuit, a Public Address System, a Wireless Microphone unit—and work out numerous other fascinating practical Radio and Electronic experiments . . . all in your own home, in your spare time.

B 90 "SYNCHRO-GRAPHIC" LESSON TEXTS*



You get 90, well-illustrated lessons prepared under the supervision of Dr. Lee DeForest, the "Father of Radio," inventor of the Audion Tube, and holder of over 300 important patents.

*All lesson diagrams and charts are printed on sheets that fold out—keeping illustrations constantly synchronized to text. This valuable DeForest's "Synchro-Graphic" feature speeds your progress by eliminating frequent flipping of pages to refer back or ahead to illustrations mentioned in text.

C "LEARN-BY-SEEING" MOVIES AT HOME

To help you master important Radio fundamentals, you use the more interesting, easier to understand visual method of Movie Instruction—

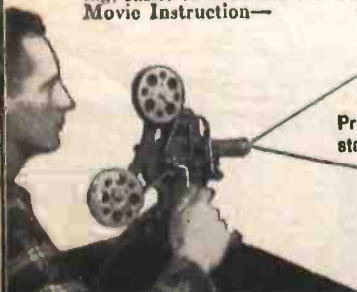

No Other Home Training Provides This Outstanding Advantage.

YOU GET THE USE OF A GENUINE DEVRY PROJECTOR AND SPECIALLY PREPARED RADIO AND ELECTRONIC TRAINING FILMS

SEE RADIO CIRCUITS IN ACTION—ELECTRONS ON THE MARCH!

DeFOREST'S TRAINING, INC.
CHICAGO 14, ILLINOIS

Cash in on the big opportunities for good pay, which the Radio-Electronics Industry offers now and after the war! Get started today towards a bright and profitable future in this fast-moving billion dollar field. Prepare now to start a business of your own, or for one of the many positions in FM Radio, Broadcast Radio, Electronics, Communications, Motion Picture Sound, etc.

DEFOREST OFFERS YOU THE MODERN "A-B-C" WAY

No other Radio-Electronics training provides all three important, basic A-B-C Training Aids at home. With DeForest's you use (A) 8 big kits of Radio Parts and Assemblies to make 133 fascinating, helpful experiments, (B) 90 "Synchro-Graphic" lesson texts, prepared under the supervision of Dr. Lee DeForest, the "Father of Radio," and inventor of the Audion Tube, (C) Use of a genuine DeVry 16mm. Movie Projector and specially prepared training films to help you learn Radio-Electronic fundamentals the visual way—proved faster, easier, more understandable. DeForest's offers all this PLUS effective *Employment Service* which helps you get started in this fast moving, opportunity industry of the future!

MAIL COUPON FOR COMPLETE INFORMATION

Let us show you how DEFOREST'S TRAINING can help YOU prepare for a Good-Pay Job or Business of Your Own. See how YOU can learn Radio-Electronics, DeForest's modern A-B-C way, in your spare time at home . . . how YOU can prepare now for the many opportunities the Radio Electronics industry offers the trained man! DeForest's Training can help YOU just as it has helped others year after year. Mail the coupon today for more complete information, including a free copy of the big book "Victory for You!" and Equipment Folder.

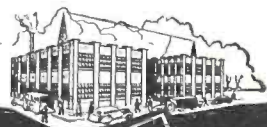

DEFOREST'S TRAINING INCLUDES INSTRUCTION IN MOTION PICTURE SOUND EQUIPMENT, FM RADIO AND TELEVISION . . . RESIDENTIAL TRAINING IN OUR MODERN CHICAGO LABORATORIES ALSO AVAILABLE — ASK US FOR INFORMATION!

E. B. DeVry, President
DeFOREST'S TRAINING, INC.
2535-41 North Ashland Avenue, Dept. RC-B7
Chicago 14, Illinois, U.S.A.

Please send me your "VICTORY FOR YOU!" BOOK and EQUIPMENT FOLDER

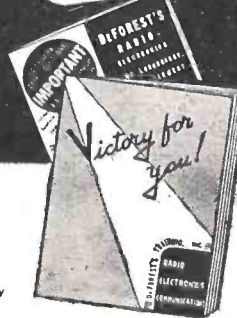

Name _____ Age _____

Address _____

City _____ Zone _____ State _____

If under 16, check here for special information.

If a veteran of World War II, check here.

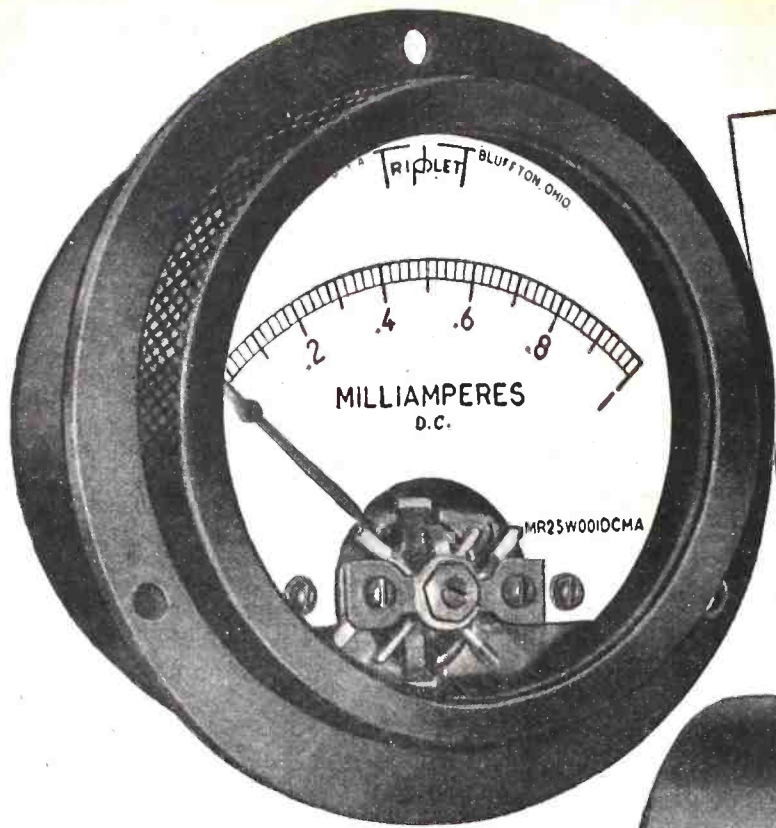

**INTRODUCING THE
NEW TRIPLETT LINE
OF
HERMETICALLY SEALED
INSTRUMENTS**

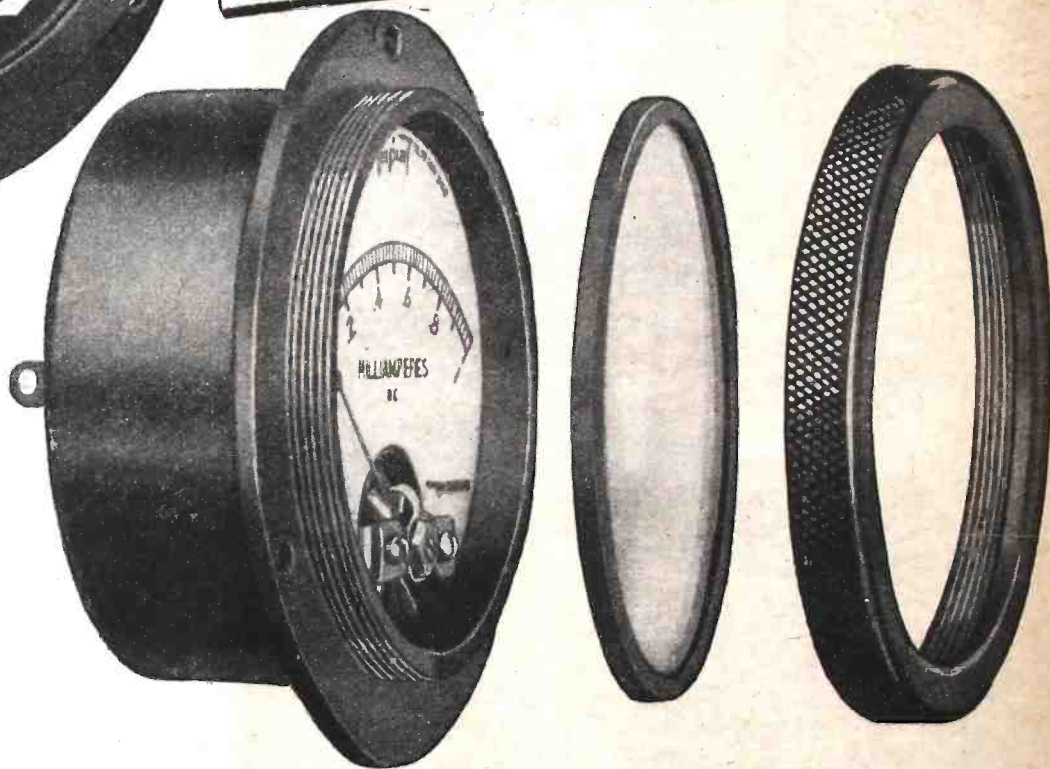
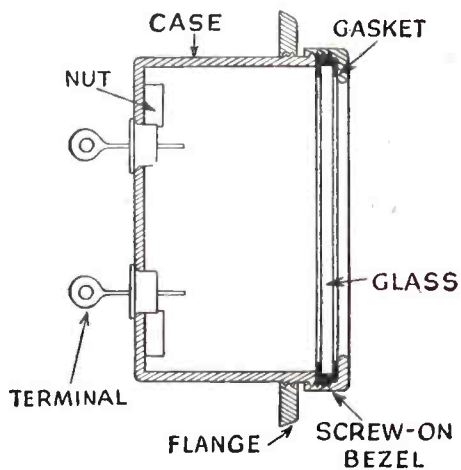

**ALL THE FEATURES of STANDARD INSTRUMENTS RETAINED
Withstands submersion tests at 30 feet**

A screw-on bezel provides uniform pressure for hermetically sealing the glass to the case. The gasket is pressed into every crevice around the edge of the glass and the top of the case, where the permanent seal is made.

Tempered glass window and ceramic sealed terminals are used.

The knurled screw type bezel permits servicing when necessary and resealing without replacing a single part or the use of special tools or equipment.

Complete dehydration of the interior is readily accomplished by recognized temperature difference

method (the bezel loosely attached for the escape of all moisture, after which the bezel is tightened to make the permanent seal). Interior is completely dry at slightly above atmospheric pressure.

These instruments comply with thermal shock, pressure and vibration tests. They also are resistant to corrosion. Instruments conform to S.C. No. 71-3159 and A.W.S. C-39.2-1944 specifications.

Furnished in 1½", 2½" and 3½" metal cases with 1/16" thick walls, in standard ranges. D.C. moving coil, A.C. moving iron and thermocouple types.

Write for circular

*Precision first
...to last*



Triplett

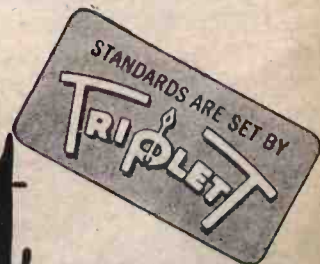

ELECTRICAL INSTRUMENT CO. BLUFFTON, OHIO

MAKE MORE MONEY

IN
Radio TELEVISION
& ELECTRONICS

Now!

GET THESE 2 BIG BOOKS

FREE!

You men already in Radio know how great the demand is for trained, experienced servicemen, operators and technicians. You know how fast the field is growing and how important it is to keep up with developments — F.M. Receivers, Electronics and Television. You know, too, a fellow cannot learn too much about any industry for **REAL SUCCESS**. Whether you have experience or are merely **INTERESTED** in radio as an amateur, you must recognize the **WONDERFUL OPPORTUNITY** right within your grasp to cash in on your natural abilities. Make them pay dividends. Get into the **EXPERT RADIO SERVICE FIELD**. Be an **F.M. and TELEVISION specialist—OWN A BUSINESS OF YOUR OWN**, if you prefer. Fill out and mail the coupon below for all the details of our plan.

Here's Just a Few of the Interesting Facts you Learn with the **FREE MANUAL**.

1. Routine for diagnosing Radio Troubles.
2. Preliminary Inspection of Receivers.
3. How to Check Power Supply.
4. How to Identify Various Stages of Receiver.
5. How to Trace the Circuit and Prepare Skeleton Diagram.
6. How to Test and Measure Voltages.
7. How to Test Speaker In Audio Stages.
8. How to Test Detector, I.F., R.F., and Mixer Stages.
9. Complete Reference Table for Quickly Locating Receiver Troubles.



Get the Latest Inside Information—Short Cuts—Trade Secrets by

SHOP METHOD HOME TRAINING

FROM A REAL ESTABLISHED RESIDENT SCHOOL
 Now the famous National Schools brings its exclusive Shop-Method of training right into your own home. You can learn the most up-to-date, approved projects, systems and circuits step by step in your spare time. This is the sound practical training you want and need—the development of experienced instructors working with thousands of students right in shops, **NEW F.M. broadcast studios and experimental laboratories of NATIONAL SCHOOLS**—one of the most advanced trade educational centers in the world.



National Trained Men Now Making the Best Money in History

The real value of National training shows up on the quick progress our men make on the job.

Incomes that seemed fantastic only a short time ago are now being reported by National graduates. And this is only a sample of what the future holds for the **MAN WHO KNOWS RADIO, ELECTRONICS, F.M., TELEVISION** and allied subjects. National is proud of the progress its graduates are making all over the world. Read the facts—the actual proof in the books we send you **FREE**.

LEARN BY DOING

Work with Real Experimental Equipment Furnished without Extra Cost as Part of Your National Training

Experience is the best teacher. You learn by experience with the exclusive National Shop-Method of Home Training. In the course of your study you actually build various types of receivers—a powerful superheterodyne, a signal generator, an audio oscillator and others—You make tests and conduct experiments that *show you the why and how of things*. You understand what makes the various elements of electronics operate because you actually see them work for you. Not only do you gain marvelous experience by this method of learning but you receive valuable equipment you will use on the job in the practice of your profession as an electronics expert. *Mail the coupon* and learn what this means to you.

Send the Coupon and prove to yourself what **YOU can do in RADIO!**

Be Sure Of Your Success And Security After The War

Don't let your post-war ambitions lag. Don't let **YOUR** future depend on others. Build a career for yourself. Never in all history has the returning serviceman, or war worker been confronted with such a great future if he reaches out and grasps it **NOW**. Here is a new world opening before you. Get ready now while you are still in uniform—while you are on your war job. Then you can soon step into an essential, well paid position or, with little capital, **GET INTO BUSINESS FOR YOURSELF**. It isn't a bit too soon to start now. Radio men are vitally needed. Fill out and mail the coupon immediately and examine the **NATIONAL SHOP METHOD HOME TRAINING COURSE** carefully, without obligation.

FREE LESSON INCLUDED

Examine the exclusive National Shop Method of Home Training. See for yourself how sound and practical it is. Be convinced that you can learn Radio, Electronics, Television—quickly and easily in your spare time. You can't tell until you try. This trial is **ABSOLUTELY FREE**. Fill out the coupon immediately while you are thinking about it and drop it in the mail at once.

Mail the coupon here for the books that tell you the complete story of the marvelous new system of training in Radio, Electronics and Television. Learn the facts of this exclusive shop-method of home training. See for yourself! **DECIDE FOR YOURSELF!**

This is the **MODERN SYSTEM OF TRAINING**: it matches the rapid progress constantly being made in Radio, Television and Electronics. It is **TIME TESTED**, too. National Schools has been training men for more than a third of a century. It is the very same training that has helped thousands to more pay and greater opportunity.

You owe it to yourself—your future—to read the book "Your Future in Radio, Electronics and Television"—**FREE** to you when you send in the coupon.

NATIONAL SCHOOLS

LOS ANGELES 37, CALIFORNIA EST. 1905



MAIL OPPORTUNITY COUPON FOR QUICK ACTION

National Schools, Dept. 7-RC
 4000 South Figueroa Street, Los Angeles 37, California.

(Mail in envelope or paste on penny post card)

Mail me **FREE** the books mentioned in your ad including a sample lesson of your course, without obligation. I understand no salesman will call on me.

NAME AGE.....

ADDRESS

CITY STATE

Include your zone number

SPRAGUE TRADING POST

A FREE Buy-Exchange-Sell Service for Radio Men



**371 OF THE 8037
SPRAGUE COMPONENTS..**

..Produced in a
Single Year!



Some idea of the extent of Sprague's war effort may be gained by the fact that it took only 365 days to produce 8037 types, sizes, and styles of Sprague Capacitors, Koolohm Resistors and other components such as those shown here. Many of the types

illustrated represent important engineering achievements which will mean still better, even more reliable capacitors and resistors for post war use. You can always count on Sprague for engineering leadership!

Ask for Sprague components by name!

WANTED—New 35Z5, 1N5, 1H5, 1A7 and 3Q5 tubes. F. E. Dickey, 237 Green St., Schenectady 5, N. Y.

FOR SALE—Dumont B-3-5 oscillograph, socket changed to take 5BP1 tube, fl. transformer added, new 5BP1 tube \$100. f.o.b. A. L. Albright, 81 Beauregard, Maplewood, La.

WANTED—Late model tube checker and sig. gen. G. T. Harrison, 209 Royal Oak, Petersburg, Va.

FOR SALE—Phone xmitter; 17 tube short wave receiver and numerous short wave parts. A. C. Nordhagen, 719 Wilkins St., Montevideo, Minn.

FOR SALE—Detrola record changer and cabinet \$49.95; power trans. all types in orig. boxes 25% off list; Radio City multimeter for any receiver \$34.95; 200 mica insulated flatiron elements .80c ea; 0Z4, 1LH4, 6SC7, 6B7, 6SK7, 47, 80, 78 tubes 25% off list. All new. Want new radio batteries, phono motors, and 1A7, 1N5, 1H5, 3Q5, 12SA7, 35Z3, 35Z5, 35L6, 50L6 tubes. Viola Austin, E. Russell Ext., Orangeburg, S. C.

WANTED—Two ea. 1A7GT, 1N5GT, 1A5GT, 1H5GT, 12SA7GT, 6A8GT, 25L6GT, 12A8GT, 12K7GT, 12Q7GT. Leyden Radio Sales & Service, 9651 Franklin Ave., Franklin Park, Ill.

FOR SALE OR TRADE—Ohlsson 60 motor with coil and condenser. Want Precision 844P V-O-M or other multimeter and modern tube tester or set analyzer. Arnold Ettinger, 280 Crown St., Brooklyn 25, N. Y.

WANTED—Triplet 686-H V-O-M. Also Howard comm. receiver 435 or Sky Buddy S-19R. R. L. Heaton, 231 Forrest St., Reading, Mass.

FOR SALE—New power trans. 750v. C.T. @ 100 ma., 5v @ 3 amps., 6.3v @ 8 amps., 2.5v @ 4 amps.; three gang condenser 450 mmf. per sec., 3/8 inch shaft; 3 gang 25 mmf. condenser, 1/4 inch shaft; 3 single gang 100 mmf. condensers, with 3/64 inch gap between plates, suitable for low and medium power transmitters, 1/4 inch shaft. All new. Harry C. Aichner, Jr., 1116 W. 24th St., Erie 6, Pa.

WANTED—V.T. voltmeter for cash. F. Williams, Box 23, Buena, Wash.

URGENTLY NEEDED—Hallcrafters SX25, S-20 or late model Sky Buddy. T. B. Barnes, RM2C, U.S.N., Radio Station, Poplar Branch, N. C.

FOR SALE OR TRADE—Large Stancor power trans. VPT-6, primary 117v. 50-60 cycles. Secondary 350-0350v 200ma. 6.3v ct. —6 amps 5 volts 3 amps. Need 2 25c8 tubes. Will buy or trade. Dozler's Radio Service, 343 S. Holt St., Montgomery 5, Ala.

URGENTLY NEEDED—6K7, 955 and 155 tubes, and other radio parts. Will trade or sell 80, 25Z5, 30, 25Z6, and 1A7 tubes. Jack Jones, Box 809, Custer, S. Dak.

WANTED—Television components; IF trans., RF coils peaking coils, etc., for FM, audio, and video channels of modern television rec. Buy all or part. I. Flores, 611 W. 137th St., Apt. 7, New York 31, New York.

WANTED—Solar condenser analyzer; Carron sig. tracer; Meissner analyst; RCA-Rider chanalyt or Hickok traceometer. Also want Riders 1 to 13, meters & test equipment, any condition. Capitol Radio Service, 109 Va. Ave., Cumberland, Md.

FOR SALE—New tubes in sealed boxes. Write for list. John's Radio Service, 503 Eastern, S.E., Grand Rapids 6, Mich.

WANTED—All kinds of Tesla and Oudin coil diagrams. James C. Reichard, 528 Daggett Ave., Pawtucket, R. I.

WANTED—10-#30, 10-1H4G, 2-1A7, 2-117Z6, 2-12SK7 tubes, also 10 in. record changer & player. D. R. Krusan, Radio & Electric Service, 2215 N. 14th St., Terre Haute, Ind.

FOR SALE—Philco sig. gen. battery operated, 110 kc. to 20 mc. bands. Takes 67 1/2v. and 2 std. flashlight batteries, \$25. R. R. Gruber, 529 Schuylkill Ave., Reading, Pa.

URGENTLY NEEDED—67 1/2v. battery for small portable RCA radio, and used Hallcrafters Sky Buddy. Cpl. Norman Cameron, ASN 17109788, Sqdn K, Boca Raton, AAF, Fla.

WILL TRADE—Kodak "3S" and Dejure exposure meter for Multimeter. Sheldon Blenstock, 46 E. 57th St., Brooklyn 3, N. Y.

FOR SALE—16 mm. silent projector & 100 ft. film; RCA 100B, 8 inch loud speaker, metal cabinet; 2 pairs earphones, 2000 ohms ea., 12 metal, 4 glass, late type 6v. tubes, slightly used, \$20. Herman Fischer, 626 Carlton Ave., Brooklyn 17, N. Y.

WANTED—Sig. gen. for 25 cycle operation. G. D. Butzer, 3181 Sandwich St., Windsor, Ont.

FOR SALE—Going radio business including test equipment, tubes, parts, 6-110v. P.A. system, manuals, fixtures, etc. Also five rooms furniture, gas range, Frigidaire and automatic water heater. Must sell due to poor health. Bey's Radio Service, 602 W. 4th St., Wilmington 15, Del.

WILL TRADE—Dayfan battery radio chassis, strong mechanism. Want typewriter or will sell for cash. W. R. Brown, 1122 S. Compton Ave., St. Louis 4, Mo.

URGENTLY NEEDED—Supreme 570; Philco 70, or other sig. gen. covering 125 kc. to 60 mc. Raymond Nuss, Box 51, Doylestown, Ohio.

FOR SALE—Weston voltmeter \$18; WRL multimeter, needs some repair \$15; A-1 Dayco tube tester tests all tubes except Acorn, \$50. Jack Blythe, 2512 Everett, Kansas City 2, Kans.

WANTED—Used books on radio theory, servicing, etc. Jas. F. Darby, 2539 A.A.F. Base Unit, Foster Field, Texas.

FOR SALE—Several 2 inch d-c milliammeters 0-100/0-200, \$3; 0-200 d-c microammeter 3 inch, \$14. Pioneer Genemeter 12v d-c to 110v. a-c. 110 w., William J. Witzel, 181 Cobbs Terrace, Rochester 10, N. Y.

FOR SALE—1 each 34, 2A6, 6D8G, 31, 58, 71A, 25B5; 2-32; 3-46, 112A; 4-01A; and 5-22 tubes. J. D. Robinson, Ontario, Wis.

WANTED—Used test equipment and odd meters for school use. Kolen P. Woods, C.E.M., TTU3, Box 14T, Camp Parks, Calif.

WANTED—0-20 micrometer, new or used. Also used motorcycle. Arthur Rosenblum, 339 Van Cortland Park Ave., Yonkers 5, New York.

WILL TRADE—K & E log. duplex slide rule, Electronics mag. from 1942 to date also radio and math books. Want test equipment or what have you? Abe Zeitz, 58 Washington Village, Ashbury Park, New Jersey.

WANTED—Following tubes in original cartons, 1A5, 1A7, 1N5, 1H5, 12SA7, 12A8, 12A7, 12K7, 12SK7, 35L6, 50L6, 35A5, 25Z5, 25Z6, 35Z5, 117Z6 and others. Also 0-1 milliamperes/1000 ohms per volt meter. J. Woscyna, 4 Yates Ave., South River, N. J.

FOR SALE—New elec. portable phono AC-DC \$49.50; one AC \$65; Triplet 1200-c V-O-M with battery \$34.25. Philco 70 table radio \$22.50. Need Chanalyt, recorder & riders 9, 10, 12, 13, 14. L. J. Arends Radio Service, Box 74, Shelby, Iowa.

URGENTLY NEEDED—1 ea. following tubes 6SG7, 6K8, 6SK7, BK29D, 25L6GT, 25Z6, 6SC7. Ceiling price. Henry A. Ecker, 4918 Denmore Ave., Baltimore 15, Md.

WANTED—Philco Radio 84 without tubes. Cash for small radios. Dales Radio Shop, Box 84, Murphys, Calif.

WANTED—Good tube tester for old and latest type tubes. Must be reasonable. Edward Price, Box 641, Erwin, N. C.

FOR SALE—Radio tubes 60% off. O.P.A. ceiling price. 2A3, 2A6, 1851, 1852, 6Y6, 2X2, 6N7, 5U4, 807, 1V, 523, 5V4, 6A6, 6V6, 6L6, 5T4, 2V3, 6F8, 874, 879. Meter tested perfect—not in original cartons. S. S. Schoenfeld, 1669 Grand Ave., New York 53, N. Y.

WARNING!

Federal laws cover the use of the mails to defraud—which means that most transactions resulting from Trading Post advertisements fall under their jurisdiction. Users of the Trading Post service are thus specifically cautioned to refrain from any dealings which might be cause for complaint to the Post Office authorities.

URGENTLY NEEDED—New or good used tube 35L6. Calvin Calhoun, 3711 E. 34th Ave., Spokane 10, Wash.

FOR SALE—Gernsback service manuals in leather binders, 1 to 5. H. H. Cilley, 1212 Amador St., Vallejo, Calif.

FOR SALE—Buick Sonomatic auto radio 1941-42; RCA farm radio, six 1.4v tubes, 4 bands; Esco motor gen. 6v input, 180v, 75ma. output, and 100-39/44; 100-52; 50-80 and 20-75 tubes. James Lawless, 496 Pleasant Valley Parkway, Providence, R. I.

FOR SALE—New portable record player for P.A. or through radio, with 78 rpm phono motor and crystal pickup. Bensman, North High, Sheboygan, Wis.

YOUR OWN AD RUN FREE!

This is Sprague's special wartime advertising service to help radio men get needed parts and equipment, or dispose of radio materials they do not need. Send your ad today. Write PLAINLY or PRINT—hold it to 40 words or less. Due to the large number received, ads may be delayed a month or two, but will be published as rapidly as possible. Sprague reserves the right to reject ads which do not fit in with the spirit of this service.

HARRY KALKER, Sales Manager

Dept. RC-75, SPRAGUE PRODUCTS CO., North Adams, Mass.
Jobbing Sales Organization for Products of the Sprague Electric Co.



SPRAGUE CONDENSERS KOOLOHM RESISTORS

TM. REGISTERED U. S. PATENT OFFICE

Obviously, Sprague cannot assume any responsibility, or guarantee goods, services, etc., which might be exchanged through the above advertisements.

Radio Can Enforce Peace

. . . Universal peace will be impossible of achievement unless we eliminate the causes of war . . .

HUGO GERNSBACK

IF the much abused "Man from Mars" would have dropped in on the 1945 San Francisco Conference, he probably would have doubted the sanity of all the conferees.

In this, the radio and electronic age of 1945, he would have been treated to the ludicrous experience of listening to the babel of over 40 languages, making it well nigh impossible for the conferees to converse, except by long time-consuming delays in translating their own talks both into English and French—the official languages of the Conference. The "Man from Mars" rightfully would have concluded that as long as the world is so backward that even its top-flight officials cannot converse in one accepted language, there certainly must be something wrong with such a world. He would reason that if such a comparatively simple obstacle as language cannot be overcome—how could the world prevent future wars? To give but a single illustration I quote from the *New York Herald Tribune*:

"The general conference confusion was perhaps best reflected in the experience of an American correspondent who asked for the text of a document and boasted he had received it by special messenger within fifteen minutes—only to discover it was in Chinese!"

It would occur to an intelligent observer that if there were one instrumentality that could and should be used to make for better understanding between the various nations of the world, that instrumentality would be radio. But so far, nothing much has been done to use this important vehicle for that purpose.

Wars come about mainly due to misunderstanding between one nation and another, or through a lack of understanding. There are, of course, other reasons but *the language handicap is probably the greatest*, in the opinion of many authorities on the subject.

But a universal language is not in sight, at least not for many generations to come. An artificial language, of the type of *Esperanto*, *Volapük*, or others, may be ruled out completely. Past experience has shown that they never can become popular.

We have a much better and more modern means of solving this most difficult and universal problem. I will attempt in the following paragraphs to show that the problem is not insoluble, but that it can be solved comparatively soon and at a cost not prohibitive.

At the present time the English language is spoken by more human beings than any other language on earth, i.e. from an international aspect. It is true that perhaps Chinese is spoken by more millions than English but not the accepted "National Language" (most Chinese is spoken in dialect where often two different Chinese can-

not make themselves understood at all).

The plan advocated would be to make the English language *compulsory* as an ultimate auxiliary language in all countries of the world. As most nations are jealous of their own language they would not wish to give it up, whether it be French, Russian or Chinese, but under the proposed plan they certainly could have no objection to teaching both their own language, PLUS the English language. This is nothing new and has been successfully done in many small countries surrounded by larger states of a different language. Thus, for instance, in Switzerland—depending on the district in which the child lives—two languages are taught simultaneously in all schools, either French and German, or French and Italian, etc. In the small country of Luxembourg, which borders Germany on the East, France and Belgium on the West, German and French are taught simultaneously; *all* citizens read, write and speak German and French with equal ease.

But for what reason and purpose would countries all over the world teach English besides their own language? Who and what would induce them to do it?

The answer to this also is astonishingly simple. To begin with, most nations have come to realize that a universal language is needed, if the world is ever to have peace. Statesmen better than anyone else realize this, and it is doubtful that many countries would not see the light within an appreciable time.

But, aside from this, there can be *two more vital compelling reasons*. They are:

THE UNITED STATES AND RADIO.

By this time the world has learned that the United States of America is not looking for territorial expansion. World War II has taught the world that the United States is ready to go to war for a principle, if necessary, without expecting to get material benefits in return for it.

The United States also, during World War II, has poured out close to forty billions of dollars in lend-lease matériel and services, to help other nations to win a war against oppression and to make men free in this world.

But the United States also knows today, as know all statesmen, that the belief World War II will be the last war, in spite of all propaganda to the contrary, is an illusion. America from now on will have to keep up huge armaments and a large military force, if it wishes to preserve the peace. That is going to be a most expensive program for generations to come. Therefore the Government will welcome any means to reduce the possibility of war, because it will not (Continued on page 674)

☆ ☆ ☆

This article is not only of tremendous importance for the preservation of peace . . . it is of vital significance to the entire Radio Industry.

If you are convinced of the soundness of the proposed plan, you may obtain from us free copies of this article to be sent with your letter to your Congressman and other Government Officials.

The Publishers

NOTING that there has been a definite increase in the amount of sound equipment being delivered by manufacturers on orders bearing ratings for maintenance, repair and operating supplies, the War Production Board's Radio and Radar Division last month reminded manufacturers that in Priorities Regulation No. 3, Interpretation 8, it is clearly stated that inter-communication systems and public address systems may not be sold on the basis of these ratings.

For an inter-communication system that was originally sold to accommodate more stations than were in service at the time of purchase, however, additional stations may be bought to build it up to its maximum operation capacity by the extension of an MRO rating, WPB said.

Sound systems may not be installed by the use of an MRO rating under any conditions, the Radio and Radar Division said.

Amplifiers, however, may be replaced through the use of MRO ratings, but only if the amplifier has been damaged beyond repair, or made unusable in some other way, making replacement necessary. Other parts of sound systems, such as speakers, microphones, and input equipment, are subject to replacement by extending an MRO rating.

Officials expressed the hope that this reminder would preclude the necessity of turning over any of the more flagrant cases to the Compliance Division for attention.

WIRE RECORDING scored another scoop last month when the surrender of a German U-boat off Cape May, New Jersey, was brought to radio audiences all over the United States within a few hours after the actual event.

Use of the standard G-E wire recorder saved the NBC correspondent who covered the affair the time usually spent in writing out a script for submission to censorship. It was merely necessary to run off the recording—blotting out the portions which were not passed by demagnetization of the wire—and the commentary was ready for broadcasting. The regular telephone was used to send it through to the New York studios, from which it could be put on the air immediately.



The first D-day attack on the Normandy coast was brought to America's people with a wire recorder. Another one is in at the victory, recording the surrender of a Nazi submarine for a subsequent broadcast.

Radio-Electronics

Items Interesting

INDUCTION heating may make its first entrance into the household as a means of rendering obsolete the cord of the ordinary electric flatiron. A patent issued last month to Lawrence F. Black of the United States Army provides for an iron and a base which is connected to a current supply.

When the iron is set on the base it is heated by induced current set up by a primary coil in the base. The inductively energized heating element is adapted to heat the sole plate of the iron uniformly and with maximum efficiency. An automatic pressure switch cuts off the energy when the iron is removed from the base.

FACSIMILE was used by the *New York Times* to transmit a four-page edition of the newspaper from coast to coast during the recent San Francisco conference.

The condensed *Times*, which contained 32 columns of news, was transmitted a half page at a time over the Associated Press-wirephoto facilities. In San Francisco the pages were put together, engravings made and the *Richmond (Calif.) Independent* ran off some 2,000 copies on a flat-bed press.

The facsimile newspapers, labeled "2 a.m. Edition," were placed in the hands of delegates at breakfast, hardly two hours after the transmission. Correspondents saw in this experiment, first of its kind in journalism, delivery of New York newspapers on the West Coast the day of publication, through radio facsimile.

Predictions of newspapers printed by facsimile have been made in the past. The San Francisco experiment shows that it is a practical possibility with present-day equipment.

NEED for radios and household appliances is mounting faster than in any year of the war, according to a report issued last month by the War Production Board. The accumulated demand is from 25 to 100 percent higher than the corresponding figures for this time a year ago.

The estimate, based on a survey of 4,500 families in forty States and the District of Columbia, asked one question: "Would you buy a radio, sewing machine, etc., right away if there were plenty of everything in the stores?" Answers indicated that no less than 5,085,000 radios would be purchased immediately if they were available. Figures on other appliances were: Electrical refrigerators, 5,825,000; sewing machines, 3,451,000; electric irons, 5,195,000 and washing machines, 5,835,000.

As to the state of the second-hand market in these appliances, the survey showed these as the buying experiences of those who responded:

Mechanical refrigerators—1,862,000 sought unsuccessfully; 411,000 bought, of which 13 per cent were new.

Sewing machines—858,000 sought unsuccessfully; 447,000 bought, of which 12 per cent were new.

Vacuum cleaners—794,000 sought unsuccessfully; 347,000 bought, of which 24 per cent were new.

Radios—429,000 sought unsuccessfully; 913,000 bought, of which 13 per cent were new, indicating "a very high second-hand market."

Electric irons—1,461,000 sought unsuccessfully; 730,000 bought, of which 48 per cent were new.

Prices paid for these second-hand receivers apparently were not an object of the investigation, but experience suggests that such research might have provided some interesting reading.

CRITICISM of radio drug and medicine advertising featured a hearing before the Congressional Committee on Labor, investigating aid to the physically handicapped, last month, according to a report in *Broadcasting* magazine. Representative Patterson of California, stating that his primary interest was in protecting the handicapped against monopoly control, excessive prices and unscrupulous advertising of medicines and devices they require, suggested that if two-thirds of the commercials on medicines and drugs were eliminated "it would be a great service to the public."

Congressman Patterson's remarks followed testimony by Richard P. Whitely, assistant chief counsel of the Federal Trade Commission, on its activities to protect the public against false advertising. Mr. Whitely stated that the Commission has ample power to stop such advertising, but only funds enough to handle the most flagrant cases. During the current fiscal year, he said, about 812,000 radio scripts and written advertisements had been examined, a decrease of 13% from last year. Of these, approximately 27,000 were marked for further investigation, a decline of 36% over last year's figures.

Monthly Review

to the Technician

LIMITATIONS on the sale of electronic equipment will remain in force till military orders show a considerable drop, members of WPB's radio and radar industry advisory committee announced last month.

The proposal endorsed by the committee calls for retention of Limitation Order L-265 *in toto* till scheduled Army and Navy orders drop to 90% of the average delivery rate for the first quarter of 1945. Then L-265 would be revised to permit unrestricted production of tubes and other parts for replacement and of all electronic apparatus except broadcasting, receiving and reproducing equipment for entertainment purposes.

When military requirements drop below 75% of the same base figure, the WPB advisory committee believe it will be possible to revoke L-265, continuing a priority system which will assure preference for military and highly essential civilian requirements over those not directly connected with defeating the Pacific enemy.

PIGEON messengers of the Signal Corps have had their efficiency stepped up many hundred percent with the aid of electronics, said a report from the War Department last month. Cellulose recordings made by electronic means have made it possible for these oldest of Signal Corps communicators to carry messages as long as a small book.

The film is in the form of a belt, 3½ inches wide and one foot long. Three inches are covered by the recording, which holds 30 minutes of speech. In case of necessity, the film can be turned inside out and another 30 minutes' talking recorded on the other side. Two of these belts can be inserted into a 4-inch capsule, which is harnessed to the back of a pigeon.

Average speech runs about 150 words to the minute, though some fast talkers can record as much as 300. Thus one film belt can hold 18,000 words, and a single bird can carry 36,000 words of recorded message.

POWER reductions ordered by the FCC to save broadcast transmitting tubes and components will be continued for the present, according to a statement issued last month by the FCC engineering department.

The order calling for a one-decibel reduction in station power was studied, and the department decided against recommending to the Commission that it be revoked. The continuing tube shortage was one reason for retaining the order, it has been learned, as well as the fact that many stations have notified the Commission that their equipment would not permit them to step up their power. A few broadcasters, Chief Engineer George P. Adair said, have asked for restoration of the power.

It was learned also that the WPB was consulted on the matter and that agency notified the Commission it was opposed to any relaxation of the order at this time.

DECISIONS on allotments to non-governmental radio services in the portion of the spectrum between 25 and 30,000 megacycles, with the exception of the 44 to 108 megacycle region, were announced by the Federal Communications Commission last month.

The unassigned space includes the controversial disputed FM area and that allocated to low-frequency television. Reason for leaving it unallocated at the present time is that the Commission felt that further measurements were desirable before making a final allocation for FM. Much evidence has been presented favoring different conclusions and further research will be necessary before the conflicting claims can be properly evaluated.

The Commission pointed out that time taken for further research and more measurements would in no way hamper the future development of FM service. Advice from the War Production Board is that the radio industry will not resume production of new, AM or FM receivers "in 1945 or even in the first part of 1946 unless Japan capitulates." Thus new allocations will be made well before there is any possibility of making new equipment to use on the frequencies allocated.

Three possible allocations are suggested for FM: 50-60 Mc, near the present band; 68-86 Mc, and the original FCC proposal, 84-102 Mc. When the 18 megacycles assigned to FM is allotted, the rest of the space between 44 and 108 Mc will be divided between television (36 Mc) facsimile (2 Mc) amateurs (4 Mc) and fixed and mobile services (4 Mc).

Another important action of the Commission is the extension of the band in the 27 Mc region allotted to scientific, industrial and medical devices, including diathermy and industrial heating. This was enlarged from the 30 kilocycles originally proposed to 270 Kc. Allocations for similar purposes in other parts of the spectrum were left unchanged.

Allocation of unassigned frequencies and a number of changes in channel widths made possible the allocation of 139 new channels.

The whole underground receiver, line wires and phone are concealed in the pipe-tobacco can, to foil searches by spying Nazis. The banana plugs are to fit a European wall receptacle.

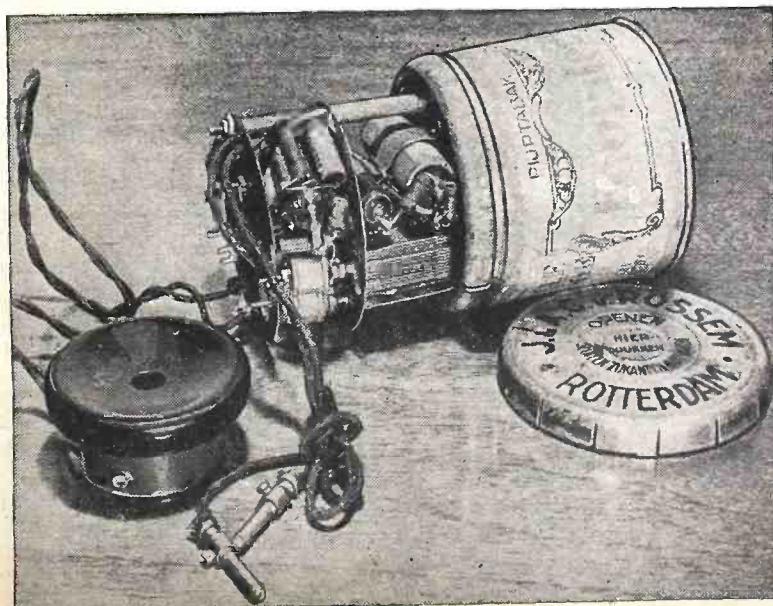

UNIFICATION of the present American communications set-up under one strong private company, with governmental control sufficient to protect the users, was recommended last month by James Lawrence Fly, former head of the Federal Communications Commission. The facilities involved would include the whole telegraph, telephone and radio communications network of the United States.

Monopoly is essential in the field of international communications facilities. Mr. Fly believes. Such facilities are invariably owned by the Government in other countries. With a single concern here, backed up by government support, Americans would be able to insist on free ingress and egress in all countries, and could secure the removal of burdensome discriminations and the establishment of direct, instantaneous circuits.

A SELENIUM rectifier unit was the heart of an ingenious underground radio made by Netherlands engineers, according to a report released last month by Philips Radio Co. The two-tube A.C. set had an output transformer to supply the filaments and the tiny selenium cells for "B" voltage. Four of the cells in series put out sufficient voltage to supply the tubes with somewhat more than 65 volts after filtering.

Sets like this one were often made to operate on current from a bicycle generator, as the Nazis cut off the electric current during British broadcasting hours and batteries were not available. Sets were also concealed in lamps, water and thermos bottles; cracker, cigar and tobacco boxes.

The Dutch were forbidden by the Germans to possess radios under penalty of imprisonment in a concentration camp or even death. In spite of this prohibition, it is estimated that 3,000 illicit sets were made in the city of Eindhoven, Holland, from materials taken from the Philips Radio Works while air raids were in progress. Nazi guard control was too strict for the materials to be obtained at any other time. In discussing the progress of their sets, one member of the underground would frequently remark to another, "Two more air raids and my radio will be ready."

Using the same technique of "borrowing" parts during air raids, the patriots also constructed small clandestine transmitters which were used to contact the underground and the British Secret Service. A Nazi operating a small quartz saw set up in one of the factory laboratories unknowingly made many of the crystals needed for these sending sets.

Microwaves

Part I—Introductory and General

By CAPT. EUGENE F. SKINNER*

ONE of the newest fields being opened to the radio world, and one which the amateur should be able to enter soon, is that of Microwaves. The subject of microwaves should be approached with the idea that there is nothing mysterious about them. In using microwaves the experimenter is merely making another move up the radio spectrum, similar to his previous move from long waves to short waves, and later from short waves to the ultra-high-frequencies.

Radio waves whose wave lengths are less than one meter have been designated as microwaves. Actually, the division between microwaves and ultra-high-frequencies is not as precise as the difference in names might imply. Very little difference exists between the higher of the ultra-high-frequencies and the lower frequency microwaves. They are in fact identical where they run into each other, and there are numerous component parts and applications which apply equally well to both frequency ranges.

As radio frequencies get higher and higher, they begin to assume many of the characteristics of light. In the microwave field these effects are very noticeable. This is an aid to handling them, but has disadvantages also. At these frequencies, it is a very simple matter to focus and beam the energy, so a very accurate determination of where the energy is going is possible. At lower frequencies, one just has to pour in the power and wonder where it is being radiated. Even if he knows, he can do relatively little to control it. At lower frequencies, the local conditions affect the coverage seriously and cannot be adequately controlled due to the tremendous size of the antenna arrays. For microwaves, the elements are small, and reflectors, especially of the parabolic type, so focus and beam the radiation that the local conditions have little

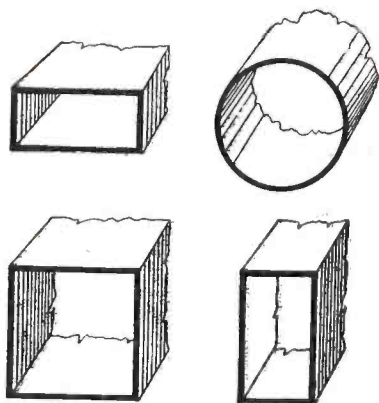

Fig. 1—Wave guides may have various shapes.

effect. The antenna arrays will fit nicely into the space limitations that most amateurs have. There is no need for large bulky arrays when a quarter or half-wavelength is only a few inches. Microwaves seem to thrive on bad weather.

The line-of-sight usable distance naturally limits the uses of microwaves considerably, and permits them to be used only for special installations. Also, "Shadows" are caused by

*Hq. AAF, Office, Asst. Chief of Air Staff, Training Aids Division.

most solid objects larger than the wave length being used, and there is negligible bending. Sky waves are unknown to date, but in any case in which they might be noticed, they would be rare and could not be depended upon for any practical use. This will discourage DX work on the part of amateurs. However, many other characteristics make their use extremely desirable, and repeater stations strategically placed could conceivably increase their range. It is probable that a "mother" set and several repeater stations might cost no more than

Radar and other wartime applications have brought microwave techniques into the practical field. Postwar applications will reach into many branches of electronics. Radio-Craft is therefore starting a series covering these important waves.

one complete station for lower frequencies.

In the wave length band between one centimeter and one meter, there is a range of 300,000 to 30,000,000 kilocycles, making available almost 3,000,000 channels for amplitude modulation and 150,000 for frequency modulation. These numbers can be amplified to an almost infinite number when the distance limitations that exist are remembered, and that high directivity will permit several stations on the same frequency in the immediate vicinity of one another.

The high directivity permitted by beaming the output makes it possible to use extremely low power outputs, even down to a fraction of a watt. For most purposes the output of a single tube is many times more powerful than is required. To date, frequency controls for the transmitter necessitate careful control of temperature and power, and are somewhat troublesome at times. However, dependable methods of locking the frequency of the receiver to that of the transmitter exists. Crystal control is not possible to a satisfactory degree as yet, because a crystal cannot be cut thin enough for these frequencies, and any frequency multiplier system merely multiplies the errors in the crystals. Greater accuracy and frequency stability is being developed in crystals, and it is possible that in the future crystal control may become practical.

Little trouble is anticipated from interference on the microwaves. Static, both man-made and natural, is practically nonexistent. In addition to getting rid of bothersome noise, this makes lower power requirements possible, due to the noise-to-signal ratio. Harmless diathermy effects may be noticed, but there is no need to worry about any damaging results from them.

In using microwaves, the mechanical and electrical considerations are of about equal importance. Parabolic reflectors may be used with the antennas, and the physical or mechanical perfection of these reflectors

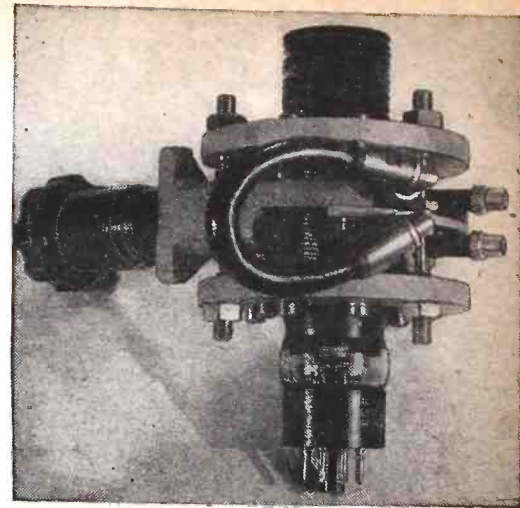

Sperry 410R Klystron, showing coaxial feed-back cable and frequency adjustment knob.

and the dimensions of the radiator itself determine the sharpness of focus of the beam, in the same manner that a reflector in a flashlight and the dimension of the bulb determines the characteristics of the light beam. "High-Frequency-Plumbing," or wave guides are used to transfer the energy from one point to another instead of coaxial cables. Coaxial cables may be used, but they are generally unsatisfactory except when used for very short distances. These wave guides may be tubular like pipe, or of rectangular cross-section area, and may be of a variety of styles (Fig. 1).

Circuit layouts must be of such a nature that there is a minimum of inductance and capacitance involved. Such minute quantities are required that the tubes are so designed as to include the quantities required for resonance within the tube. From this, it can be seen that such things as interelectrode capacitance are of great importance. Naturally, with such physical characteristics involved, the overall size of a system is automatically much smaller. A mechanical consideration in the design of the tubes is the transit time of the electrons, which becomes of great importance. The wave lengths are so very short that if the tube is of appreciable size, the time required for an electron to travel from one element to another might readily be a considerable portion of a cycle, or even several cycles, as in the Klystron.

Experiments have been made with satisfactory results for using microwaves in con-

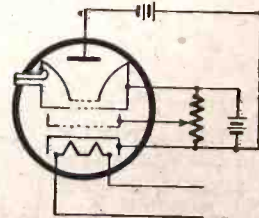

Fig. 2—Simplicity of microwave hookups is typified in this basic Klystron reflex circuit.

junction with moving railroad trains for control and conversation. Considerable success has been attained in such work, and certain railroads now experimenting with lower frequencies intend to move into the microwave region as soon as it becomes possible to get equipment. Many of the applications are shrouded in wartime secrecy, and will undoubtedly be revealed at a later date. Aircraft-to-ground and aircraft-to-aircraft communications should adapt themselves readily to this means, especially

(Continued on page 659)

TUBE REPLACEMENTS

Part I—Direct Replacements Which Require No Wiring Changes

By I. QUEEN

THE tube substitution problem remains as bad as ever. Recent predictions bar any improvement for months to come.

Frantic radio servicemen are being reduced to seeking substitutions for the tube substitutions now in radio receivers. Even the war's end will not completely solve the tube problem. Long after all types are again made available servicemen will still be confronted with receivers using emergency tube arrangements, some possibly inefficient, ineffective or tending to short tube and component life, and therefore no longer considered satisfactory. The same principles which now apply to tube substitutions will again be made use of when restoring the tubes for which the set was designed.

To aid in the finding of replacement types, various lists have been made available. Most of them are conservative and reliable, giving great help to the serviceman. A few, unfortunately, recommend wild substitutions without the proper technical changes required, inviting damage to both tubes and components. It is better that the set remain inoperative solely because of lack of proper tubes, than because of damage to components and new tubes.

It would be splendid if these lists could detail complete information involving replacement types for every tube in the handbook. Over 2000 different types of tubes are available, however, so we have to be content with something less Utopian. Lists divide the necessary changes for a replacement into "wiring change", "voltage change", etc. In general they must leave details to the serviceman's skill.

The use of tube substitution lists involves the use of a tube manual or "bible" as well. Here the differences of voltages, current and other characteristics are noted so that the newly-installed tube may be operated properly. Where most lists recommend "no change" it is still wise to consult the handbook and verify that the two types concerned are really directly replaceable.

It may well be kept in mind that in general, every tube type differs slightly from all other types, otherwise it would carry the same designation. On the other hand, all types fall into a few groups so that the experienced technician providing the necessary changes in the set, will always be in a position to keep the radio operating.

TUBE DESIGNATIONS

Early in 1933, the RMA tube numbering system came into use. Each tube was given three symbols for identification; the first (number) showing filament voltage, the second (letter) giving its function, and the third (number) indicating the number of useful elements brought out externally. The first letters of the alphabet signified an amplifier, the last letters a rectifier. This is a simple system which would prove of great help in these days, but, unfortunately, it has not worked to perfection, partly because of the great number of different tubes brought out and the many previous tubes not so numbered. Thus, the following are quite dissimilar: 6A7-12A7, 6A5-12A5, 6B8-12B8, 25Z5-35Z5, 6C8-12C8, 6B7-12B7. We repeat, consult the tube manual in all cases.

In seeking a tube replacement, the following procedure may be found useful:

1. The new tube type must have the same general function (oscillator, detector, etc.) as the original. It is also possible to use two tubes (such as oscillator tube and a mixer tube) for a single oscillator-mixer tube. Hard-to-get diode tubes may be replaced by triodes with grid and plate connected.

2. Filament, plate and grid voltages and currents must be similar. Most tubes permit variations of 10%. After that, it is wise to make the necessary alterations in the set wiring to accommodate the replacement.

3. Some substitutions can be made after a simple socket connection or wiring change. Adaptors are available for making some of the more common changes. These are merely plugged into the original socket and are then ready to receive the replacement. No rewiring is necessary and the set can use the original tube when available by removing the adaptor.

4. Space and shielding requirements should be checked. In general, a glass replacement for a metal tube should be shielded, especially if in the R.F. portion. The metal tubes and their G, GT, GT/G counterparts are electrically identical but of different size, sometimes putting the ultra-portable at a disadvantage. It is well to re-align the set where changes are made in R.F. and I.F. circuits.

There is no definite procedure to follow except for the more common substitutions. The serviceman's technical ingenuity is the only limit to adaptations which can be made when the radio must be kept "alive." Low-gain, multi-stage amplifiers sometimes operate well with one stage eliminated, A.C.-D.C. receivers operating on D.C. only may do without the rectifier tube, etc.

Fortunately, some tubes may be directly replaced by other types with no changes required in general. These are given in the table of direct replacements (Table I). Voltages and currents are either exactly the same or well within the permissible tolerance. Other characteristics are also similar and no rewiring of any kind is necessary. For example, the well-known interchangeable combination, 5Z3-80 has not been mentioned. The writer has made this substitution many times even before the tube shortage and no noticeable change was ever noted. However, to keep the list uniform and to close tolerances, it has been omitted.

Some of these types are exactly the equivalent of others except for the cut-off value. Ordinarily these are also directly

replaceable, but this is not always true, especially in delicate noise-quieting circuits or some AVC circuits. In such cases it is well to try the replacement. If distortion results on loud signals when replacing a remote cutoff with a sharp cutoff tube, minor changes must be made. Sharp cutoff tubes work well only on smaller signals so that some auxiliary volume control may be necessary to keep the grid voltage within limits. Changing from a sharp cutoff to a remote cutoff may slightly decrease sensitivity in some circuits.

Never follow the lists blindly. They are not intended as a substitute for judgment and skill in maintaining radio receivers. Let us give some examples. Assume that a Firestone S7406-7 is brought in for repair. It is an 11-tube, radio-phonograph combination. Suppose that a test shows that the 6SQ7 A.F. tube is defective. No serviceman need be reminded that this is a most lamentable situation.

Before becoming desperate or returning the set to the customer the wise serviceman will glance at the schematic. Here he finds that there are three other 6SQ7 tubes in the circuit, one of them being used as a detector (Fig. 1A). Second glance shows that it is not being used as a high-gain duo-diode triode but rather as a simple diode. All elements (disregarding filament) except one diode plate are connected to the cathode. It should be a simple procedure to insert this tube into the A.F. socket and substitute either a diode or some easily obtained triode (Fig. 1B) with the necessary slight rewiring. (Note the unusual 6SQ7 filament connections.)

Take another example. Assume a defective detector (6H6) in the RCA model VHR-307 receiver. Fig 2 shows that only one diode is in use. Should this one go bad it is not necessary to institute a tube-hunt, if the other diode section and filament still operate. Merely change the wiring slightly to accommodate the good diode of this tube or any other 6H6 with one effective diode still operating.

When replacement of a metal tube for a glass is taking place, note the socket connections. It is often true that pin No. 1 of the glass tube octal socket is used as a support, possibly of the high voltage lead. Since this is also the shell connection of a metal tube, such a lead should be transferred elsewhere.

Part I has discussed tube changes in general and those which do not require major circuit changes. In Part II we will describe voltage and current changes which may be necessary and how to make them.

(Continued on page 656)

Figs. 1A and 1B—How a special replacement job may be done when the serviceman gets a "break." Fig. 2—A lucky receiver for a detector replacement.

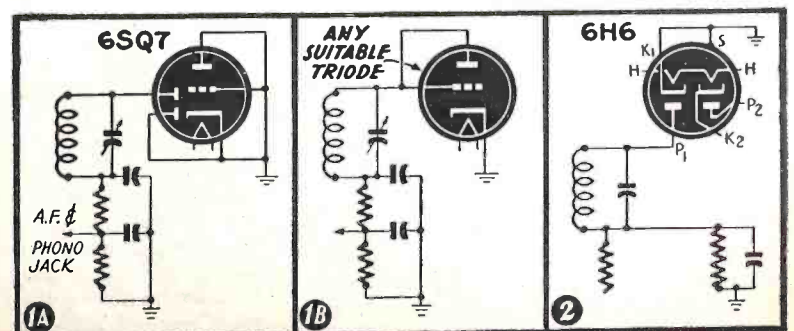

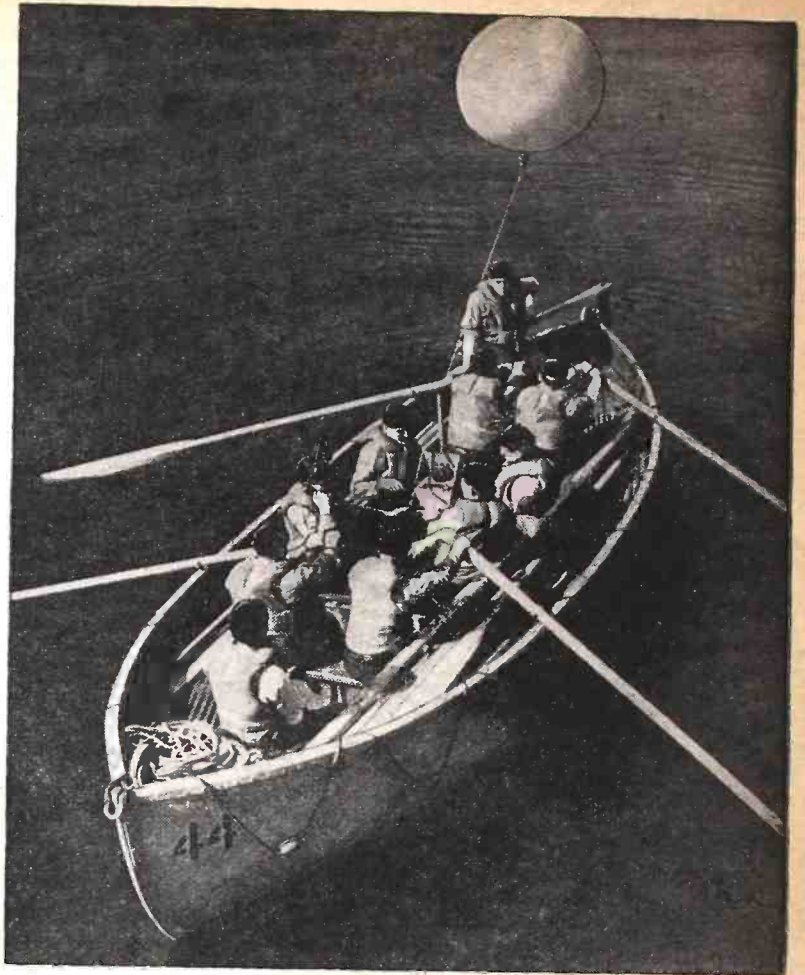
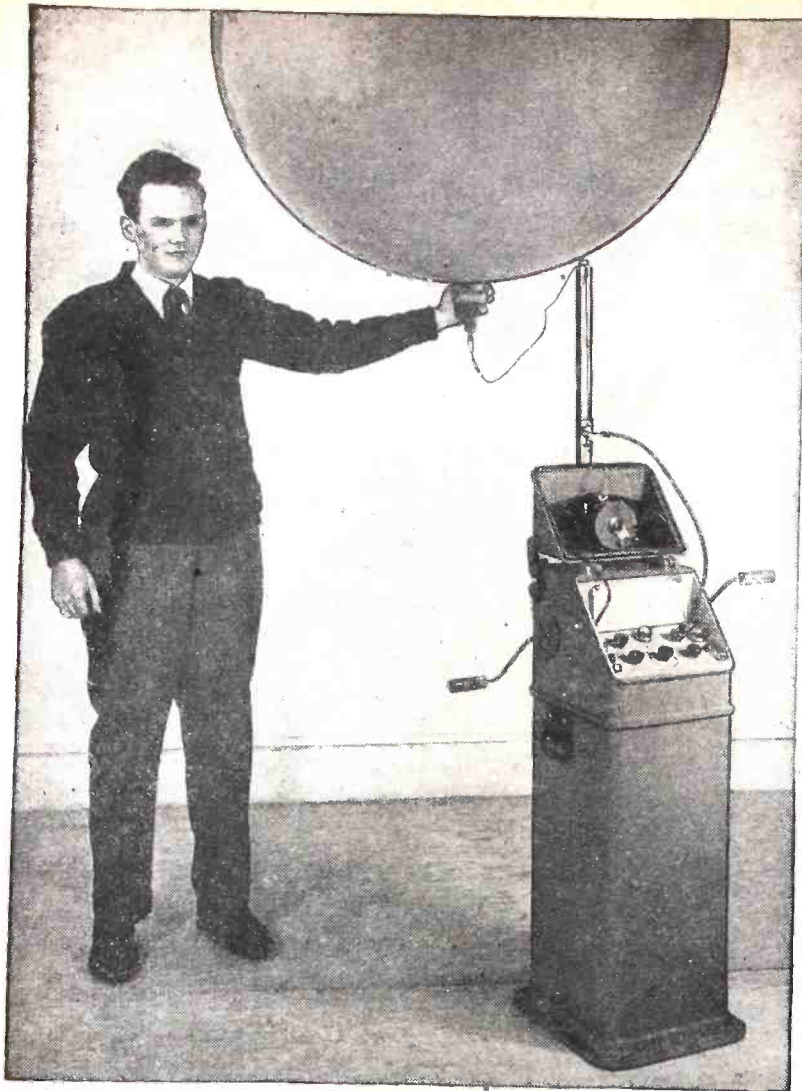

Left—The complete apparatus with its balloon "sky-hook."
Right—Sailors test the equipment in a regular life-boat.

COVER
FEATURE: *New* **LIFEBOAT RADIO**

By CHARLES J. PANNILL*

FOR several years certain passenger vessels have carried radiotelegraph lifeboat equipment, and soon after this country entered the war the U. S. Coast Guard and the Federal Communications Commission issued regulations requiring lifeboat radio gear on cargo vessels. The advantages of this wartime move are self-evident.

After a ship has been abandoned and its personnel has disembarked in lifeboats, there arises the major problem of providing suitable facilities so that the lifeboat may be located by rescuing vessels. At the time of the emergency, the lifeboats may be far from the nearest land and the occupants may have only an approximate knowledge of their position. Through the use of a radio installation the morale of the men in the lifeboats is appreciably improved by the knowledge that contact has been made with rescuing agencies.

The first portable lifeboat radio sets designed to meet the Government regulations were battery-operated transmitters using only a 500 kilocycle frequency. Such equipment left much to be desired because of its limited communication range and restricted power supply. In addition, because the equipment did not include a receiver, there was no way for the men in the lifeboats to know whether their distress signals had been intercepted by rescue craft.

In conducting its research and experiments with advanced models, Radiomarine

Corporation of America proceeded on the basis that lifeboat apparatus should derive its power supply from a hand-driven generator, rather than from storage batteries, in order to insure reliable operation at any time. Furthermore, to insure maximum transmission ranges, a high frequency (short wave) was allocated by the Government in addition to the conventional distress frequency of 500 kilocycles. For most efficient transmission and reception, a suitable antenna system is needed, preferably one which is not restricted by the height of the boat's sailing mast.

Because each lifeboat may not have a trained radio officer aboard, it is also important to design the equipment so that anyone, by following simple instructions, can use the equipment to summon aid. This calls for both two-way radiotelephone and radiotelegraph apparatus, all housed in a single unit. Moreover, the entire installation must be immune to weather conditions so that it will continue to function in spite of salt spray or heavy rain.

All of these requirements are met successfully in the new lifeboat radio pictured on our cover and the illustrations on this page. A compact water-tight binnacle contains a complete radio transmitter and receiver, a built-in hand-driven generator power supply unit, a telephone handset, a telegraph key, and a reel containing 300 feet of antenna wire. The radio transmitter may be used for either voice or code transmission, and delivers five watts of power

to the antenna on frequencies of 500 kilocycles and 8,280 kilocycles. Using the lower frequency, average distances from 50 to 200 miles can be covered; the short wave facilities radiate a signal which can be picked up over distances of 1,000 miles or more.

In addition to the conventional voice and code facilities, the transmitter incorporates a fully automatic cycle of operation. When the master switch, on the panel is placed in the "Automatic" position and the hand generator is cranked, an ingenious, fully automatic, keying device transmits groups of SOS signals to summon aid and special "long dash" signals for radio direction finder bearings. The same keying mechanism also changes the transmitter frequency back and forth between 500 kilocycles and 8,280 kilocycles, while the generator is being cranked. This insures that the signals are radiated to cover both short and long ranges without further attention on the part of operating personnel.

When two-way communication is needed, the master switch is used to switch the radio receiver into the circuit. This receiver is pre-tuned to the distress frequency of 500 kilocycles and also can be tuned to sweep the short wave band from 8,100 to 8,600 kilocycles. Once communication with ships or shore stations has been established, the two way feature permits the drifting lifeboats to exchange information that will expedite rescue operations. In addition, be-

(Continued on page 666)

*President, Radiomarine Corp. of America

A "Jewell" Ohmmeter

Versatile Resistance Checker from Old Test Instrument

By R. S. HAVENHILL

WITH the scarcity of meters and test equipment for experimenters becoming more acute daily, obsolete analyzers such as the Jewell 199 are being taken down from the shelf, dusted off, and critically examined to determine what can be done with them. The analyzer section of these units became obsolete with the advent of the screen grid tubes. The volt and milliammeter sections are still good. The inadequacy of this unit is mainly due to the fact that it does not contain an ohmmeter. This article describes the construction of a miniature ohmmeter which measures resistances from a few tenths of an ohm to 40 megohms. In addition to the usual battery-operated shunt and series circuits this little unit features a built-in 300-volt D.C. power supply made with an audio transformer, which furnishes power for a 0-5000 ohm range and a 0 to 40 megohm resistance range. Consequently this unit need never be put on the shelf for want of battery replacements which are not forthcoming.

The photograph shows the unit, complete with batteries and power supply, built into the right hand side of the test lead compartment of the Jewell 199 analyzer. While the unit was designed for the Jewell 199, it can, with slight modifications, be used with any good 1-mil meter.

The following resistance ranges are available:

Resistance Range	Half Scale Ohms	Type Circuit	Power Source
0 to 500 ohms	25	Shunt	Batt. 7.5 V.
0 to 5000 ohms	250	Shunt	Batt. Pwr. supply 7.5 V. or 300 V.
0 to 1 meg	7,500	Series	Batt. 7.5 V.
0 to 40 megs	300,000	Series	Power sup. 300 V.

CONTINUITY TESTING

0 to 1 megohm range

For ordinary continuity testing the series type circuit is preferred as the meter reads toward full scale if the circuit has continuity and reads zero if circuit is broken. The series type circuit as shown in Fig. 1, is used. Resistance measurements are based on Ohm's law.

$$I = \frac{E}{R} \quad \text{or} \quad R = \frac{E}{I} \quad \text{or} \quad E = IR$$

I = Current in mils
E = Voltage in millivolts (1000 × Volts)
R = Total resistance of circuit in ohms

The test leads B, A are first shorted and the meter is set to full scale or 1 mil by adjustment of Rv. The unknown Rx is then connected to B, A and the meter reading taken. Knowing the resistance of the meter

(Rm) and the voltage of the battery E, the resistance of Rx can be calculated using Ohm's law. Meter readings for a number of values of Rx can be calculated and recorded on a chart. By reference to this chart, knowing the meter readings, the values of the unknown Rx can be read off.

For example, suppose Rx = 15,000 ohms.
R = Rv + RL + Rm + Rx =
R = 650 + 6,600 + 250 + 15,000 = 22,500 ohms
E = 7.5 volts or 7500 millivolts

$$I = \frac{E}{R} = \frac{7500}{22,500} = \frac{1}{3} \text{ of a mil}$$

The meter then will read 1/3 of a mil or 1/3 of full scale.

The best scale to use on the Jewell meter for all ohmmeter work is the 0-15 scale. On this scale the meter will read 1/3 of 15 or 5 divisions.

The formula for calculating the calibration chart would be as follows:

$$\text{Meter Reading} = \frac{7500 \times 15}{7500 + Rx}$$

112500

7500 + Rx

If the meter had an 0-1 scale the factor 15 would be omitted. If you desire to use the 0-7.5 volt scale the factor 15 would be replaced by 7.5. Meter readings for about 30 different values of Rx can be tabulated on one-half of one side of a 3 x 5-inch card. This card should be slipped into a transparent cellophane envelope which will protect it from dust, dirt, abrasion, etc. Such a chart is more easily read than the usual crowded non-linear ohmmeter scale. A few values for this chart are shown in Table No. 1. The 0-15 scale was used.

If accurate standard resistors are available the meter can, of course, be calibrated with them. The accuracy of the meter is also affected by increase in the batteries' internal resistance with age. B1 was chosen as 6,600 ohms so zero adjustment cannot be made when the batteries become too old to use.

For low resistance measurements (0 to 5000 ohms) the "kickback" or shunt type circuit is used. In this circuit the unknown resistor Rx is shunted across the meter and causes a kickback or decrease in meter reading, hence the name "kickback or backup" circuit. This circuit is shown in Figure 2. The zero adjustment (full-scale meter read-

ing) is made without shorting the test leads; the unknown Rx is then connected in the circuit and the meter reading taken. The relation of meter reading to unknown Rx can be derived as follows using Ohm's law.

I = total current from battery (1 mil.)

I₂ = current through Rm or meter

I - I₂ = current through Rx. (The sum of the currents through Rx and meter = total current I.)

(E = IR)

Voltage drop across Rx = (I - I₂) Rx

Voltage drop across Rm = I₂ Rm

However voltage drop across meter = voltage drop across Rx as they are in parallel.

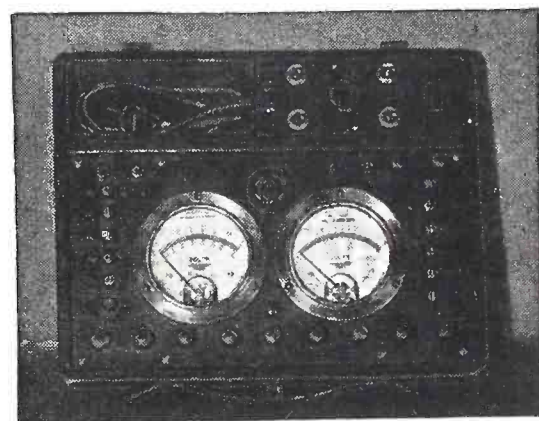

The Jewell 199 with its built-in ohmmeter. Complete circuit of ohmmeter and power pack.

Therefore I₂ Rm = (I - I₂) Rx

I₂ Rm + I₂ Rx = I Rx

I₂ (Rm + Rx) = I Rx

I₂ = I Rx

Rm + Rx

Since the current I is 1 mil the formula

$$\text{becomes } I_2 = \frac{Rx}{Rm + Rx}$$

Since the 0-15 scale on the meter is used the final formula is as follows:

$$\text{Meter reading} = \frac{15 Rx}{Rm + Rx}$$

(0 to 15)

As an example:

Suppose Rx = 500 ohms, the meter will read

$$\text{Meter reading} = \frac{15 \times 500}{250 + 500} = 10 \text{ or } \frac{1}{3}$$

(Continued on following page)

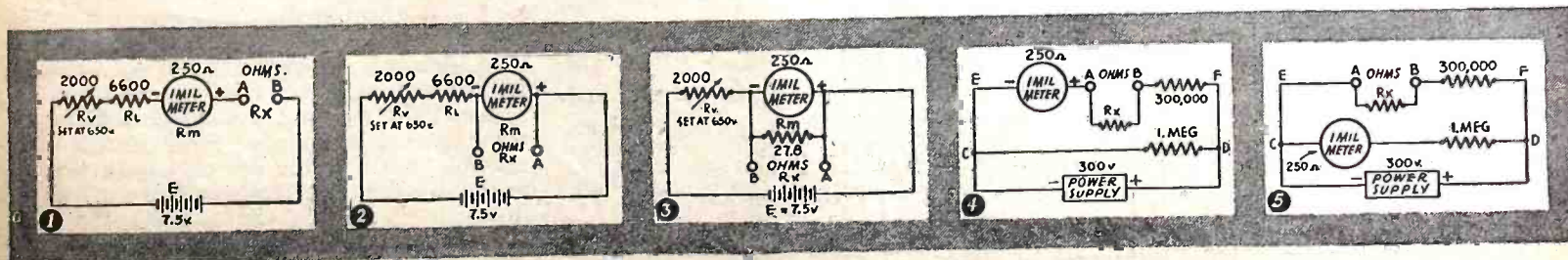

Figs. 1-3—Medium, low and extra-low-ohm ranges. Figs. 4 and 5—High-ohm, high-voltage ranges.

(Continued from previous page)

full scale of the millimeter's full-scale reading.

Using this formula a few values have been calculated and are shown in Table No. 2. These values can be tabulated on the righthand side of the card for the series circuit for convenience.

ERRORS IN THE SHUNT CIRCUIT

In the shunt circuit small variations in battery voltage and internal resistances can be compensated for by means of the zero

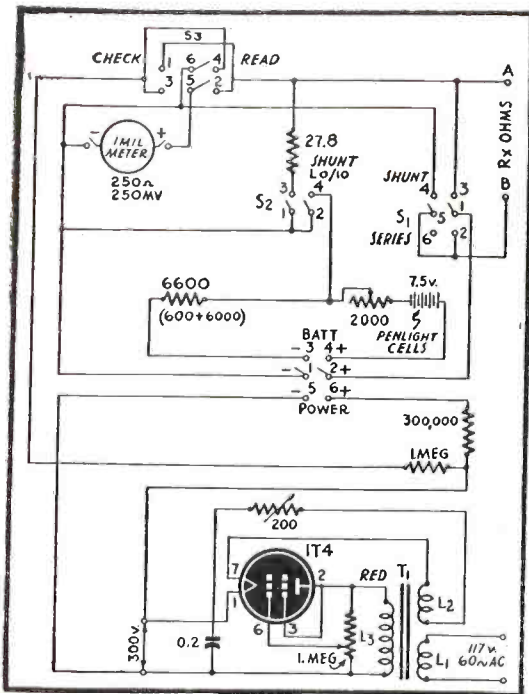

Complete circuit, ohmmeter and power pack.

adjustment using R_v . The total current in this circuit is the same with or without R_x in the circuit. This is not strictly true, especially if R_x is only a few ohms, as it shunts the meter and decreases the total circuit resistance, which allows more than one mil of current to flow. This amounts to less than a 5% error if R_x is around 5 ohms and decreases as R_x increases. To minimize this error, R_m should be small in comparison to $(R_v + R_1)$. Consequently when the 300-volt power supply is used to operate this range this error is completely eliminated. This error is merely pointed out as one which is present in this type circuit and if other circuit constants (for example a lower battery voltage) than those shown are used the error may become appreciable. This error can, of course, be eliminated by using in the derived formula the actual value of 1

(calculated from Ohm's law) in place of the 1 mil value used. It can also be eliminated by calibration against known values of R_x .

LOW OHMS CIRCUIT

To measure very low resistances the meter resistance must be low, as when the meter resistance is equal to the shunt resistance half the current goes through the shunt and half through the meter; so the meter reads half scale.* The meter is shunted with a 27.8 ohm resistance so that its new resistance is 25 ohms. Since the meter resistance is now 1/10 of its original value it will draw 10 times as much current (10 mils) and the resistance range will be exactly 1/10 of that for the circuit of Figure 2. A meter reading of 0.30 would indicate an R_x of 0.5 ohms. This means that the values of R_x in Table 2 can be divided by 10 ($L_0/10$) and a new chart will not be necessary for this circuit. The circuit is shown in Figure 3. It will be noted that R_L has been removed to allow the increased current to flow through the circuit.

It is a good idea to check this low range against standard resistors, thus taking into account the measurable resistance of the test leads.

MEGOHM RANGE—0-40 MEGOHMS

It has been shown that with a 7.5-volt battery in the series circuit resistances of nearly a megohm can be measured. A 300 volt power supply would then enable resistances of 40 times $(300/7.5)$ or 40 megohms to be measured.

A 300 volt DC power supply which occupies a space not larger than $2\frac{1}{2} \times 3\frac{1}{2} \times 2$ inches is rather difficult to build. A miniature power transformer should be used but this is not available. A.C.-D.C. type power supplies must not be used as one side of the line is always hot and there is danger of shock and power line shorts. The solution to the problem is to use an old transceiver transformer or a modified audio transformer which can usually be found in the junk box. The circuit—which is not conventional—is shown in Figures 4 and 5. L_1 is the plate winding, L_3 is the secondary or grid winding of the audio transformer. L_2 is the microphone winding. The microphone winding will put out about 11.4 volts at 50 Ma, so a 200-ohm resistor was used to drop the voltage down to 1.4 for the IT4 rectifier filament. In case a transceiver transformer

*This is a good way to determine the internal resistance of a meter. Simply shunt it with a resistor of such value as to give a half scale deflection, then the shunt resistance will be equal to the meter resistance.

is not available an audio transformer can be used by winding one layer of No. 32 enamel wire around the present coil. This job is not too difficult and has been described in past issues of *Radio-Craft*. The voltage which this winding puts out will have to be checked and a suitable dropping resistor used to reduce the voltage to the required 1.4 volts. In order not to burn out a good tube it is advisable to connect a 28-ohm resistor in place of the tube filament and adjust the 200 ohm dropping resistor until 1.4 volts is obtained (across the 28-ohm resistor) when measured with a 1000 ohms-per-volt AC meter. The 28-ohm resistor is then removed and the tube filament connected up. The IT4 miniature tube has a battery type filament but has been found to operate satisfactorily in this circuit on AC. Plate voltages over 90 volts are not recommended by RCA for this tube; however, voltages of 400 have been used on this tube in this circuit where not over 1.3 mils of current are drawn. The tube in this circuit has been in use for over a year and has suffered no ill effects.

The screen is tied to the plate of the IT4, making a half wave rectifier out of it. The grid is connected to the arm of the 1 megohm potentiometer which is connected across the secondary winding. By changing the grid potential the voltage delivered by the power supply can be conveniently varied. The 0.2-mfd 600-volt condenser across the 1-megohm resistor acts as a filter. A condenser of 0.4 mfd will give a higher power supply voltage than the 0.2 mfd unit; however a capacitor larger than .4 mfd will cause a decrease in voltage. Not over 1.5 mils should be drawn from this type power supply as very small wire is used on the transformer.

The disadvantage of this type power supply is its high internal resistance which may be 100,000 ohms against say 1000 ohms for a power supply using a regular transformer. This high internal resistance which may not be constant causes the transformer to put out a variable voltage depending on the amount of current drawn during the resistance measurement. This introduces an error in the resistance measurement. A voltage regulated power supply is out of the question where a miniature unit is desired so a special circuit was developed to neutralize the effect of voltage variations.

THE COMPENSATING CIRCUIT

In order to measure resistance the power supply voltage must be known and constant when R_x is in or out of the circuit. The current through the resistance R_x must also be known. By using the meter first as a voltmeter and adjusting the voltage of the power supply to exactly 300 volts when R_x is in the circuit and then switching the meter into the circuit as a milliammeter both the current and voltage can be measured and R_x can be accurately determined. The circuit is shown in Figures 4 and 5. In Figure 4, the meter is connected as a voltmeter at CD and measures the voltage across the power supply. 300 volts produce a reading of 4.5 on the meter (0 to 15 scale). This can be calculated using Ohm's law and it can be shown that 0.3 mil will be drawn by the meter and 1-megohm multiplier.

In Figure 5, the meter has been switched from CD to EF. Here it acts as a milliammeter to measure the current flowing through R_x . The circuit resistance is not changed in either the EF or CD branches as the 250 ohmmeter resistance is negligible in comparison with either 1 megohm or 300,000 ohms.

In making a resistance measurement R_x

(Continued on page 668)

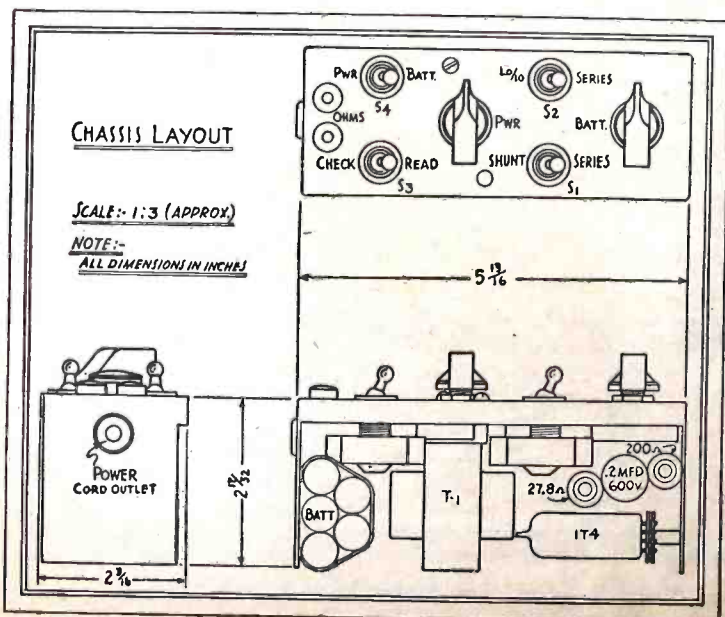

Fig. 7—The top, end and side elevations of switching circuit and power pack of the meter. While very compact, it is not difficult to get the various parts into place.

RADIO REPAIR IN BED

By RUBY MOORE HUFF

PRIOR to Pearl Harbor, the island invasions, D-day and the crossing of the Rhine an article of this type had no place on *Radio-Craft's* table of contents. With the ever-increasing flow of handicapped veterans returning to home hospitals or civilian life, much time must be given by trade journals and technical periodicals to help the lads who form that stream. They paid for their fate with a precious contribution to victory, now it behooves us to help lead them to something that will be a means for them to find the self reliance that the maimed condition crushed.

This repairman was not able to stand side by side with the fellows who paid. Probably, though, the victory that he won over his condition will give some of the disabled boys a buoyant push that he could not have given as a comrade-at-arms. With that hope we pass his story to the attention of any who may benefit from it.

The 100% chemurgic city of Laurel, Mississippi, has the distinction of having one of the most expert radio repairmen in the South. This man, Wesley A. Rushing, has been bed ridden for seven years. He is a self-made expert in radio servicing.

He spent his childhood on a farm about eight miles from Laurel and attended school in the rural district. Later he entered high school in Laurel. In registering at that school, he was classified for a course in General Science. That, to young Rushing, meant little more than just a means to earn a credit, until the class reached a chapter in the text that gave an explanation of radio. The instructor, a Miss Cobb, gave a demonstration of the lesson so clear that the lad, who had never had a close-up view of a cabinet—much less a chance to see the "innards" of one—had an awakening. Then and there a genius was brought to being. He decided that he too could do things with wires, tubes and dials. He did tinker with them for a time and spent many hours at stores and shops where radios and radio parts were sold. The work seemed so complicated to him that he let the bug-bear of needing quick money side track his interest, and found an easier way to get a livelihood. He did not get enough courage to tackle radio again until after he was disabled.

For several years after repairman Rushing became ill, he was not allowed to work or worry about anything. The gritty little man made a fight to improve his health. By the time he could turn in bed, the desire to know more about radio revived. He could not go to the city library to read about radios or go to the places that handled them, but he did not despair. He ordered several instruction books on radio repairing. He not only studied those books but insisted on testing out each lesson. His determination and their desire to give the sick man something to look forward to, caused his wife and father to take an interest in the hobby. They purchased the items of equipment that he requested and set them up for him, in reach of the bed.

The first piece of testing equipment that he had installed was a Supreme (Model 502) combination of tube tester, voltmeter, ohmmeter and condenser checker. He gradually accumulated supplies enough to make repairs on radios for his friends. The work

that Rushing did on such jobs stood up so well and gave so much satisfaction that the news of his ability to do a good repair job passed around. That grape-vine advertising soon brought him more work than he could well handle while the customers waited.

The equipment and procedure of Rushing's servicing are of simplified technique, but from the crude work bench by the side of his bed grew the Rushing's Radio Repair Shop. The shop has for its slogan the well known "Satisfied Customers Are Our Best Advertisement." He is a firm believer in Ralph Waldo Emerson's way of detailing the grapevine news circuit. "If a man can write a better book; preach a better sermon; or make a better mouse trap than his neighbor, though he build his house in the woods, the world will make a beaten path to his

10—Set repair prices and collect charges when delivered; that eliminates details of bookkeeping and assures cash on hand at all times.

Mr. Rushing states that aside from purchasing price of his lot and modest little building, the installation of his working equipment cost around one hundred fifty dollars. On the bench beside his bed are the Model 502, Victor signal generator (Model 42), solder, soldering irons, screw drivers and incidentals; also telephone. He uses that equipment, but states that a repair set-up could (in case of necessity) start functioning with much less, say, voltmeter, ohmmeter, tube tester, signal generator and a few incidentals picked up from a five-and-ten counter. It doesn't matter so much what elaborate assortment of tools are strewn on the bench, so long as the worker has that



door." Be that as it may, the room where the repairman was working was stacked with all types of radios.

With the set-up shown in the photo, he works an average of 10 hours per day and repairs two hundred radios each month. Mr. Rushing works on any type, but he unhesitatingly stated that he preferred RCA. (No plug . . . just his choice.)

When asked how he went about repairing, he detailed a routine in the following steps:

- 1—Plug the set into the outlet . . . if it lights up the line-cord is O.K.
- 2—Apply audio signal to second detector.
- 3—If signal is reasonably audible, the audio amplifier is working.
- 4—Check back with RF signal generator through the successive stages until signal goes dead, indicating the defective stage.
- 5—Pull from cabinet.
- 6—Locate trouble, the faulty stage, by voltage or resistance test.
- 7—Check supplies to see if parts needed for that job are on hand.
- 8—When trouble has been corrected and the works replaced in the cabinet . . . retest. And check!
- 9—Never start a second repair job until the one on the table is completed or completely repacked to await repair parts.

essential stick-to-it-ive-ness — because the work is tedious. He gave out that bit of information because he felt that many returning veterans, who had been disabled, would like to get into established trade for which their training may have fitted them; but hesitate to undertake the venture on the account of the capital that they believe it might take.

To those handicapees who wish to try the adventure of setting up for radio repairing his advice is: Go at it now! The pre-war sets are giving way and quite a span of time may pass before the post-war machines can replace them.

Mr. Rushing's advice is to avoid much confusion by learning the simpler art of the present trade accurately and do your work well, before you go into a flurry over the new fangled features promised for post-war radio.

Let us hope that this article will help many a disabled person fight that post-war battle of gaining self-confidence and earning a good living (for that's dough in them that radios, much more than in them that Apple Carts.)

Note: The seat by Mr. Rushing's bed is where his wife or brother sits to hand him tools and plug in the testing instruments. The brother—a returned war veteran—is also learning the trade.

YESTERDAY'S CIRCUITS

By J. W. STRAEDE*

At the moment, set building is in abeyance owing to lack of parts. That makes it a good time for raking over the circuits of bygone days and seeing what splendid ideas have been allowed to die out. Many circuits come and go and stay gone—they were merely novelties. Others have remained with us, changing their dress from year to year but remaining the same old circuits at heart.

The most famous and best remembered were those that attempted in their design to overcome one or more of the troubles formerly (and still!) experienced in radio reception. What were these troubles? In the early twenties the two outstanding ones were lack of volume (due to lack of gain) and multiplicity of controls. Attempts to boost the gain by adding R.F. stages usually resulted in extra tuning controls, regeneration controls, stabilizers, etc. The gain obtained from even a "good" R.F. stage was seldom as much as 12 db. "Poor" R.F. stages often resulted in a loss!

With the increase in power and number of broadcasting stations, lack of selectivity became annoying owing to overlapping—many were the jokes about "my set's better than yours, it can receive two stations at once."

The demand for selectivity meant added complexity in the form of wavetraps, extra

*Straede Electronic Laboratories, Preston, Victoria, Australia.

R.F. stages (more controls!), freak aerials (generally useless) and a growing popularity of the superheterodyne receiver.

Some circuits of the good old days, when there was magic in circuits, are no longer with us. Among them are the Isofarad, Peridyne, Neutrodyne, Infradyne, Cockaday, and the One-control Regenerative. See Fig. 1 for some of them. Each of these has failed to continue existence because its *raison d'être* has departed. Neutralization went out in a hurry when screen-grid tubes came in, hence the death of the Isofarad and other neutralized T.R.F. receivers including the Neutrodyne and Browning Drake. The T.R.F. principle, however, has survived, though only just.

Matched coils and matched gang condensers are now possible of manufacture, so the Peridyne and Solodyne with their inductance adjustors have departed—if inductance adjustment is to be performed today it is done by means of iron-dust cores and not by a loss method.

The Infradyne was a superhet in which the intermediate frequency was the *sum* of the signal and oscillator frequency. Certainly it removed double spotting, but today efficient pre-selection can do the trick better.

The Cockaday, a regenerative detector circuit, employed a crude form of preselection in which tuning was done in steps with a tapped coil—regeneration being controlled by a loss method (partial absorption into an out-of-tune circuit).

Now what of the circuits that have survived? The Reinartz, T.R.F., Superhet., Reflex, Super-regenerative and Interflex are still with us. The Reinartz, a regenerative detector, is still used in the 2- and 3-tube short-wave sets. It is still the most sensitive circuit that can be built with a limited number of tubes and still be very critical in adjustment. Two-tube Reinartz sets have brought in stations from thousands of miles away at loud-speaker strength—today pentode detectors and high-amplification power tubes have made the Reinartz and other regenerative detector circuits still more efficient.

Neutralization of feedback caused by inter-electrode capacities has died out, but the tuned-radio-frequency receiver has survived. It was revived when "all-electric" sets came into general use and has recently come into popular notice as a high-fidelity circuit for the reception of local stations. "Cutting of sidebands"—one of the disadvantages of the sharply tuned superhet—is partly eliminated by the more broadly

tuned T.R.F. Another advantage of the T.R.F. is the fact that it is free from the "birdies" or "chirps" that are often heard at some parts of the dial when a superhet is used.

Just as the Neutrodyne has lost its neutralization and become the hi-fi local set of today, so the Browning-Drake has discarded its neutralization and become the midget T.R.F. mantel receiver. In the old Browning-Drake, regeneration was obtained by the use of a rotatable feedback coil connected in the anode circuit of the detector; in the "Pee-Wee" mantel set, regeneration is obtained from capacity between the grids of the R.F. and detector tubes. This capacity may be due to the location of the wiring or the proximity of the two sections of the gang condenser.

The superhet of today has not so much survived as died out and been reborn. Early supers were expensive to build, unnecessarily selective, difficult to tune and full of distortion. This due partly to overloading of tubes and partly to the suppression of oscillation by making some of the grids positive. When all-electric sets came in, the super was forgotten for a few years—then A.C. supers came in with a bang and showed the electric T.R.F. sets what they could do in the way of distance-getting and station separation.

One old-timer that is still with us, or at any rate with the ultra-short wave experimenters, is the super-regenerative. Great claims were made for this circuit at one time. Owing to the large amount of regeneration made possible, it does have a terrific gain, but the selectivity is inherently poor and there is generally a background of hiss. Possibly some enterprising manufacturer of midget sets will revive the super-regen, fitting it with an efficient preselector stage and using the super-regen detector to drive a small speaker directly.

The Reflex circuit in which the same tube is made to amplify the signal at two (or more) different frequencies has been revived from time to time. One of the earliest

(Continued on page 667)

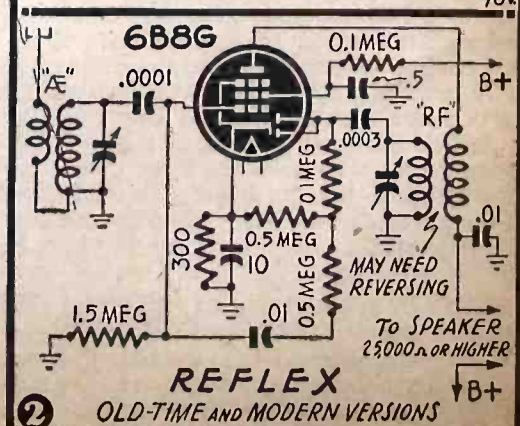
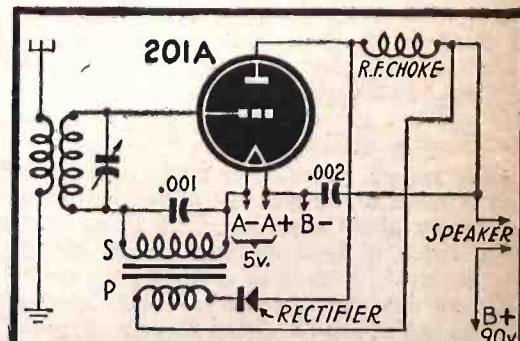
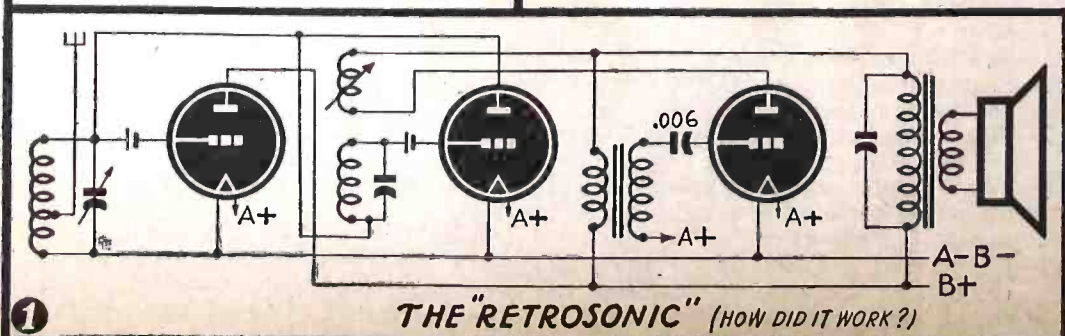
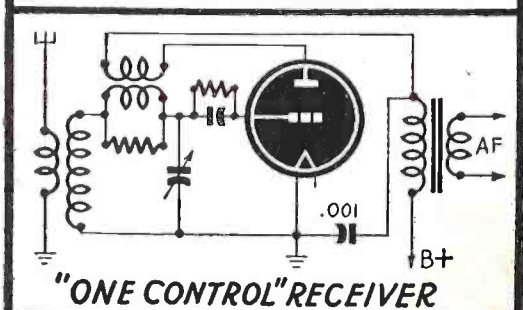
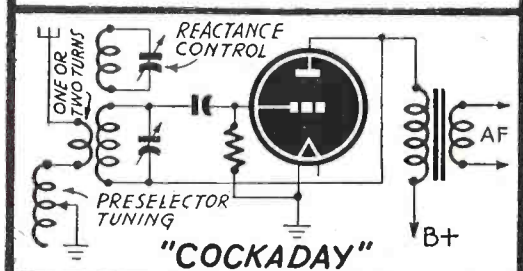
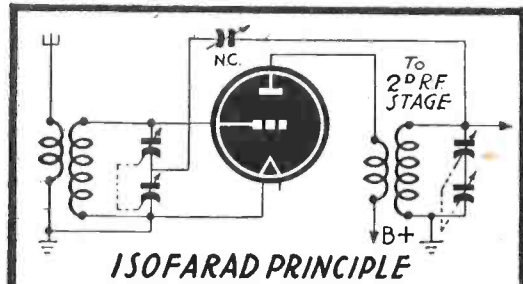

Parasitic Oscillations

Part I—Circuits and Tubes for Stable Operations

By STAFF SGT. DEAN STOCKETT EDMONDS, JR.

THOSE who design and build their own receivers may, in general, be divided into two groups. The beginner in radio—in a spirit of boundless enthusiasm—designs a set with three or four pre-selector stages (R.F. amplifiers) and a similar number of I.F. amplifiers. The old-timer—warned by past experience—is mortally afraid of using an R.F. stage and scarcely dares hope that his one I.F. stage will be a success. If the novice goes ahead with his multi-stage plan, his set is surely doomed to failure. The reason—long known to the old-timer—is instability due to parasitic oscillation. People may talk about problems of selectivity, tracking, and tuning, but everyone who designs and builds his own superhets will agree that parasitic oscillation is probably the most outstanding of all his problems.

Parasitics in transmitters are usually at widely differing frequencies, either very low or U.H.F. They are caused by conditions which do not exist for the most part in the R.F. and I.F. stages of receivers and therefore will not be considered here. The parasitic found in receivers is almost invariably of one type: In one stage, or a series of stages operating on the same frequency, there exists sufficient feedback from output to input to sustain self-oscillation. In short, the stage or stages involved act as a tuned-plate-tuned-grid oscillator. If a cascade of stages is involved, the oscillations may be of the relaxation type, but in any case they will be at the operating frequency of the amplifier—the I.F. frequency if it is an I.F. stage or stages at fault, or the receiver's operating frequency if the trouble is in the R.F. amplifier. For this reason, the presence of parasitics may be easily detected in a receiver. They appear at the 2nd detector as a strong unmodulated signal which are impossible to tune out (unless the oscillation is in the R.F. section of the set, in which case there may be settings of the dial at which the Q of the tuned R.F. circuits is such that the feedback becomes insufficient to sustain oscillation). If a set shows a strong signal over all or most of the tuning range and reception is weak and accompanied by beat notes on either side of the exact setting of the dial for any given station, it is surely a victim of parasitic oscillation.

A TYPICAL AMPLIFIER STAGE

Let us take a single stage of I.F. amplification, remembering that what is said about this case applies equally to an R.F. amplifier stage or to a series of stages of either R.F. or I.F. amplification, so long as each stage operates on the same frequency. A typical I.F. amplifier is shown in Fig. 1. Anyone who has worked with radio at all will recognize it as standard. But let us analyze it as an oscillator. We have a tube with correct bias, screen, and plate voltages applied and with a tuned circuit in both the grid and the plate circuits. These tuned circuits are the secondary of the input and the primary of the output I.F. transformers respectively, but this is immaterial. The point is that we have a tube whose grid and plate circuits are tuned to the same frequency. The usual

R.F. or I.F. amplifier, then, has every feature of a tuned-grid-tuned-plate oscillator except one—plate-to-grid feedback. In triodes the required path lies through the grid-plate interelectrode capacity of the tube, but the modern pentodes designed for R.F. amplification are made with especially low grid-plate capacity, so that feedback through this path alone is insufficient to sustain oscillation. It is the problem of the designer and constructor to make certain that no other feedback path is left complete. Let us see how this may be done.

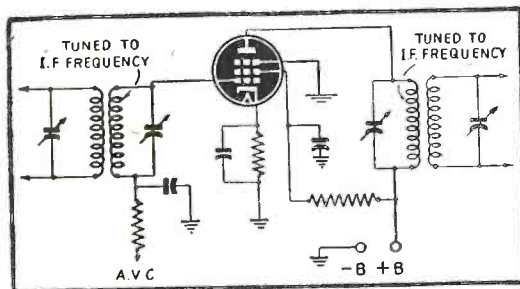

Fig. 1—Circuit of standard I.F. stage.

While *theoretically* the grid-plate interelectrode capacity of the amplifier tube is the only method by which the output is coupled to the input, *practically* there are hundreds of other paths through which feedback may occur. The better the design and construction the less good these paths will become, but complete elimination in the absolute sense is close to impossible. In comparatively low-gain receivers (say those employing a single I.F. stage and no preselector), the problem is simplified since the feedback voltage required to sustain a parasitic is relatively high, and therefore if some sources of feedback are not eliminated harm may not result. It is, of course, obvious that the higher the gain of an amplifier the smaller the amount of feedback required to sustain oscillation. Since the elimination of feedback paths is a ticklish business, reduction in gain is often resorted to as a substitute remedy.

THE RIGHT AND WRONG WAY

Thus we may prevent the I.F. or R.F. amplifier of a receiver from oscillating by two different methods: elimination of feedback paths, or reduction of the amplifier's gain to the point where existing feedback is insufficient to sustain oscillation. The latter method is exceedingly popular with amateurs because it is very much easier and with certain commercials because it is very much cheaper. All you have to do is to put a high value resistor in the screen or cathode circuit, or both, thus decreasing the screen voltage and increasing the bias respectively, and there you are. The gain of a modern variable-mu pentode is directly dependent on its bias and screen voltage, and by increasing the former and decreasing the latter the gain is quickly reduced below the point where inherent feedback will cause the amplifier to oscillate.

Since reducing the gain correspondingly reduces the receiver's sensitivity, this method of parasitic elimination is a very miserable compromise with quality and efficiency to say the least. Any discrim-

inating experimenter who wants to get the most from his tubes will be quick to condemn it.

Let us begin by ruling out any compromise with quality and assume that whatever tube is chosen for an amplifier will be operated at voltages which will cause it to display maximum gain. Pentodes of the variable-mu class, which are especially designed for receiver R.F. and I.F. amplification, will form the group from which our choice will be made. The grid-plate interelectrode capacity in these types is held to an absolute minimum, thus minimizing that feedback path, and the variable-mu feature allows the use of A.V.C. without blocking or distortion and permits the handling of signals of widely varying strength without cross-modulation.

TUBES FOR R.F. AND I.F.

One of the most familiar R.F.-I.F. amplifiers is the 6K7, and this tube is a very reliable standby for a conventional stage. Its grid-plate transconductance runs around 1600 micromhos and its grid-plate capacity is around .005 mmfd.—quite low enough to maintain good stability. In addition, it is a metal tube, an advantage in that the grounded shell provides more complete shielding than does the shield placed about a glass tube.

There are many tubes in this class, having various styles of bulb construction and filament characteristics, so that the designer may choose one to suit his particular needs. The 6K7 is a metal tube with a filament rated at 6.3 volts and .3 amperes. The 6S7 is similar but draws only .15 amperes on the filament. Other representative types in this class are the 6U7G—a glass tube with an octal base and a 6.3-volt .3-ampere filament—the 6D6 and the older 78—glass tubes with 6-prong bases and 6.3-volt filaments—the 58—the type with the 2.5-volt filament—and finally the 7B7 representing the "loktal" style.

Also belonging to this class, although displaying slightly higher gain and efficiency than the others, is the single-ended model of the 6K7—the 6SK7. This tube is of particularly recent design and employs an internal shielding and wiring arrangement which not only keeps the grid-plate capacity down to a maximum of .003 mmfd., but also reduces dielectric losses, especially at the higher frequencies, and slightly increases the tube's grid-plate transconductance. It and its loktal counterpart, the 7A7, form one of the best choices a designer can make for a reliable amplifier stage displaying excellent gain and efficiency. The 6K7 and 6SK7 are also made with 12.6-volt, .15-ampere filaments and in the bantam or "GT" style. The type numbers for these types are 12K7, 12SK7, 6K7GT, 6SK7GT, 12K7GT, and 12SK7GT.

When it is desired to get maximum gain from a stage in a receiver where the number of stages is limited, a number of tubes display considerably higher mutual transconductance than those of the 6K7 class. Representative types are the 6AB7/1853, the 6AC7/1852, the 6SG7, and the 7G7/1232. The 6AC7 and 6AB7 have grid-plate trans-

(Continued on page 662)

An Electronic Omnichecker

Part II — Construction Details

By ROBERT E. ALTOMARE

INFORMATION has already been given regarding the Diode Head but it is well to emphasize by repetition here that the leads inside the head *must* be kept short to maximize the input impedance; this, of course, does not apply to the leads from the diode head to the voltmeter proper as these leads carry only D.C. and may be any convenient length—especially if shielded.

The diode head was made from a 3½-inch length of 2¼-inch aluminum tubing which happily was available. Force-fitting covers were made for both ends. A circular plate was forced into the aluminum tube about half-way inside to act as a mounting for the 9002 midjet socket for which a hole was drilled, thus entirely shielding the tube.

An insulated banana jack was mounted on one end. To this jack was wired one end of the parallel .01 mica condensers.

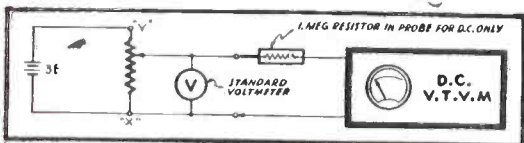

Fig. 8—Method of calibrating the instrument.

Now two banana plugs are mounted back-to-back, one end plugging into the jack and the other forming a short probe to the circuit under measurement. Another banana plug, uninsulated, is mounted off to one side and acts as the common lead. This construction permits a very short hot lead. The common lead may be extended when necessary by means of a short length of wire and a clip.

Fig. 4 (in Part I) and Fig. 9 show the simple electrical circuit. The A.C. voltage picked up by the input terminals and ap-

plied to the plate of the tube charges condenser C_{11} , consisting of 2 high-grade .01 μ f mica condensers in parallel. This paralleling was necessary since a .02 mica condenser was not available. Since the reactance of C_{11} is purposely made small and the time constant of C_{11} and R_{31} large C_{11} will charge to almost the peak value of the applied A.C. voltage. This charge remains constant except for the very short duration pulses on the positive peaks of the applied A.C. During the remainder of the cycle C_{11} discharges through R_{31} and the plate has an average negative polarity with respect to the cathode.

The A.C. component of this pulsating D.C. is removed by decoupling filter C_1 and R_{31} at the grid of V_1 while the negative D.C. voltage is applied to the grid of V_1 and indicated by the amount of meter deflection. Switch S_3 must be in the "minus" position when measuring A.C.

Resistors R_{24} through R_{30} are again used to extend the range, this time of the A.C. voltmeter, the same ranges being available for both A.C. and D.C.

Although the peak value of the A.C. voltage appears at the output of the condenser diode rectifier, the meter dial is calibrated in terms of root-mean-square volts for a sinusoidal input, or .707 of peak for a complex A.C. wave. This is accomplished simply by setting up the instrument for the 1.5v A.C. range and applying a known voltage of 1.5 volts A.C. to the diode probe, then adjusting a calibrating resistor in the VTVM for full-scale deflection of the meter.

The 1.5-volt scale is not linear and a special calibration is provided on the meter

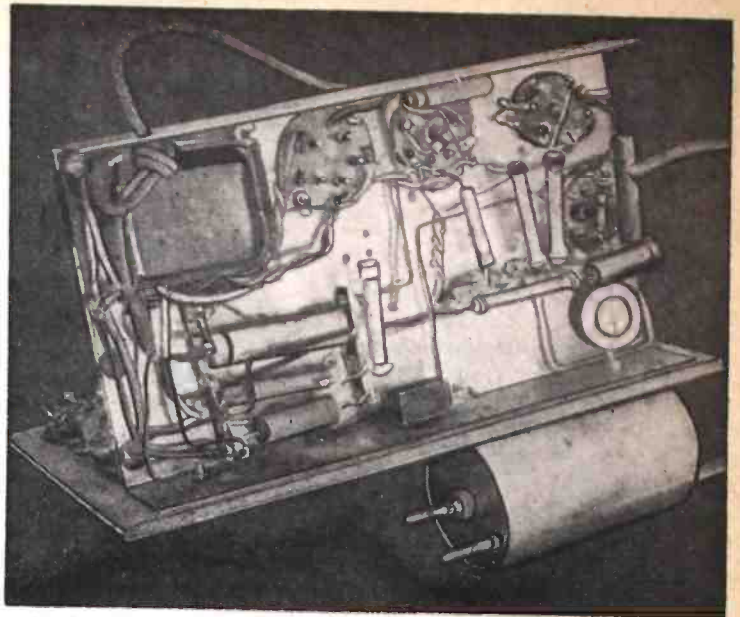

Under-chassis layout also shows how diode head is made.

dial—Fig. 1. For all other A.C. ranges the calibration is essentially linear and the D.C. scales are used.

The small penlite cell B_2 and adjustable potentiometer R_{32} function to buck out the negative voltage generated by the diode due to contact potential. To balance this out, short the input terminals of the probe and note the meter will read up scale. By adjusting R_{32} , the meter needle can be brought back to zero. Once adjusted, R_{32} need never be touched unless the 9002 tube is replaced. Hence a midjet potentiometer may be used and the shaft slotted to permit screwdriver adjustment.

Note that the heater voltage of the 9002 is reduced to approximately 3.5 volts by the filament-dropping resistor R_{33} . In addition to stabilizing and reducing the contact potential, a long life is assured for the 9002 tube.

SEQUENCE OF WIRING

It is suggested that the units be wired in a logical sequence. Since the D.C. voltmeter is the "heart" of the instrument, it should be wired up first and then checked. The power supply is incidental to this procedure and must be completed along with the D.C. section.

When convinced that the D.C. voltmeter is functioning properly, the vacuum-tube ohmmeter circuit may be added and tested. Following this, the vacuum-tube capacity meter and A.C. voltmeter may be wired in to complete the assembly.

(Continued on page 664)

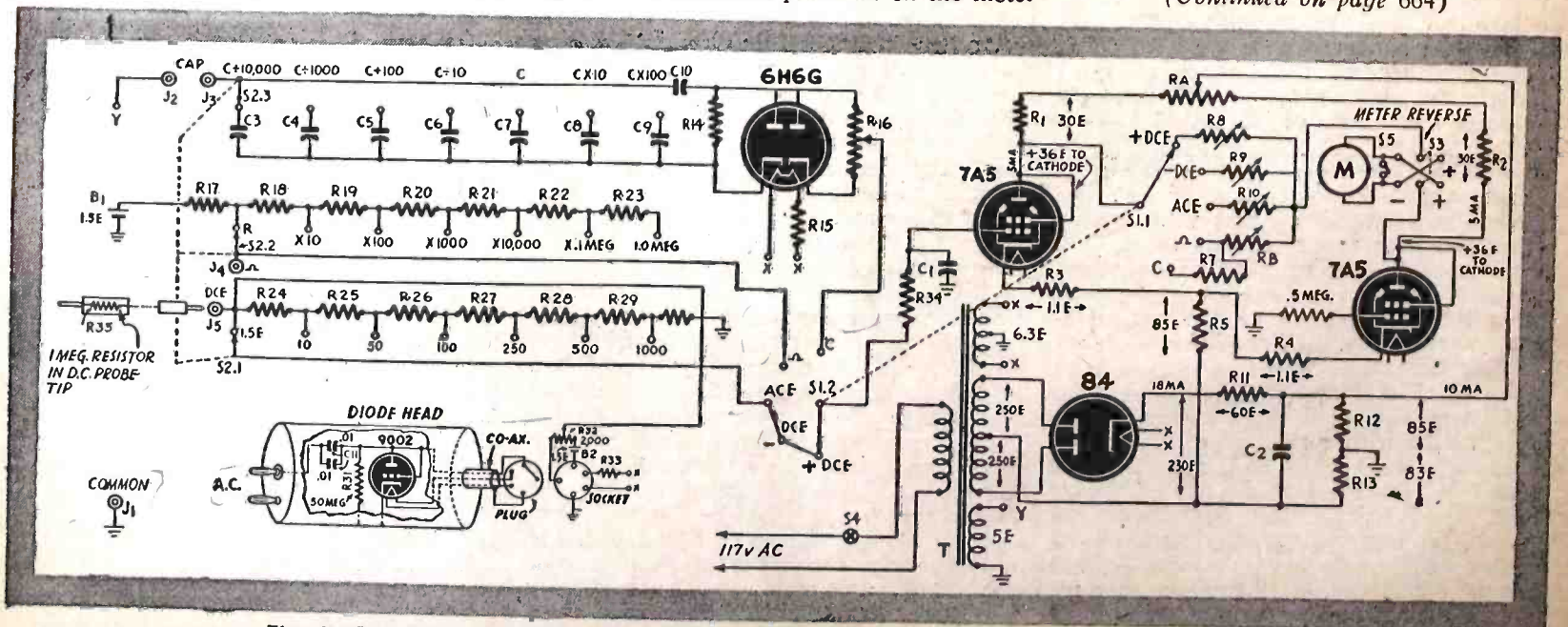

Fig. 9—Detailed schematic of the Omnichecker. "Breakdown" diagrams appeared in Part I.

Oscilloscopes For Trainees

By "SCOTTY" KEILLOR*

ELECTRONICS men fondly refer to the Cathode Ray Oscilloscope as the "scope." It is an instrument which is in universal use today, and "tomorrow" will find it an indispensable item in all lab and workshop equipment. The war has resulted in amazing advances in the development of this instrument, and in the uses for which it is adapted.

The oscilloscope is built around the Cathode-Ray Tube, the electronic device that makes television and other modern electronic miracles possible. The May 1944 issue of *Radio-Craft* carried an article on cathode-ray tube applications in making electronic circuit checks. It was shown how

tion of its many capabilities. In spite of its complexities, however, the oscilloscope can be mastered.

In order to make use of it in many of its potential applications, the amateur or professional technician will find it essential to be familiar with the scope itself.

The cathode-ray tube is the actual unit we use to view pictures of electronic action. The CRT encloses a stream of electrons which are emitted from the cathode to strike the fluorescent screen on which we view the electronic action. This stream can be affected by voltage potentials applied near the moving negative electron stream. To move or deflect the stream from its normal path, we apply voltage to deflection plates, placed at right angles to each other inside the tube. See Fig. 1. A positive voltage attracts the stream, a negative voltage repels it from the plate to which that voltage is applied.

Remembering that any action of the scope involves force applied to this electron stream, we can inspect the circuits and controls of the scope. Knowing the circuits and controls will enable us to use them to best advantage, and to service them when trouble occurs. Fig. 2 is an oscilloscope circuit. This is not any one of the common commercial models, but is reprinted from a construction article in *Radio-Craft* because of the clear identification of each component and control.



Controls are not complicated once thoroughly understood.

A smaller cathode-ray tube and lower voltages are used—otherwise the schematic is typical of practically every instrument now in use. A study of these two drawings in conjunction with the text should make the student feel quite at home with the average oscilloscope.

OSCILLOSCOPE CIRCUITS

The Power Supply (Fig. 2, left) is necessary to provide voltages for the CRT itself, and for the various other tubes in the scope. Scopes operate on 115 volts A.C., so the transformer has an input primary of that rating. This transformer has secondaries for providing filament voltages, plate and screen voltages, and CRT voltages. Different types of scopes will of course use different power circuits, so exact analysis will depend on the scope used.

The CRT Voltage is a high voltage taken from a secondary and half-wave rectifier, the upper one in the circuit. The voltage is fed through a filter circuit and across a voltage divider, giving the high voltage and small current necessary for operation of the CRT. The purpose of this circuit is (Continued on page 652)

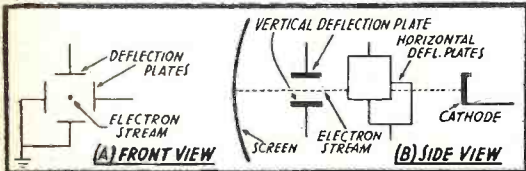

Fig. 1—How the electron stream is deflected.

the scope could be used for signal tracing, alignment, and modulation analysis. The October and November issues described industrial uses of the tube. There are many other important uses of the scope, such as frequency comparisons, output measuring, and distortion checks.

The instrument is not simple, and many servicemen or trainees have been overcome by the mere sight of it. Even on benches where it is used, lack of sufficient knowledge of its operation prevents full utilization. *Sergeant Kingsley P. Keillor, U. S. Marines.

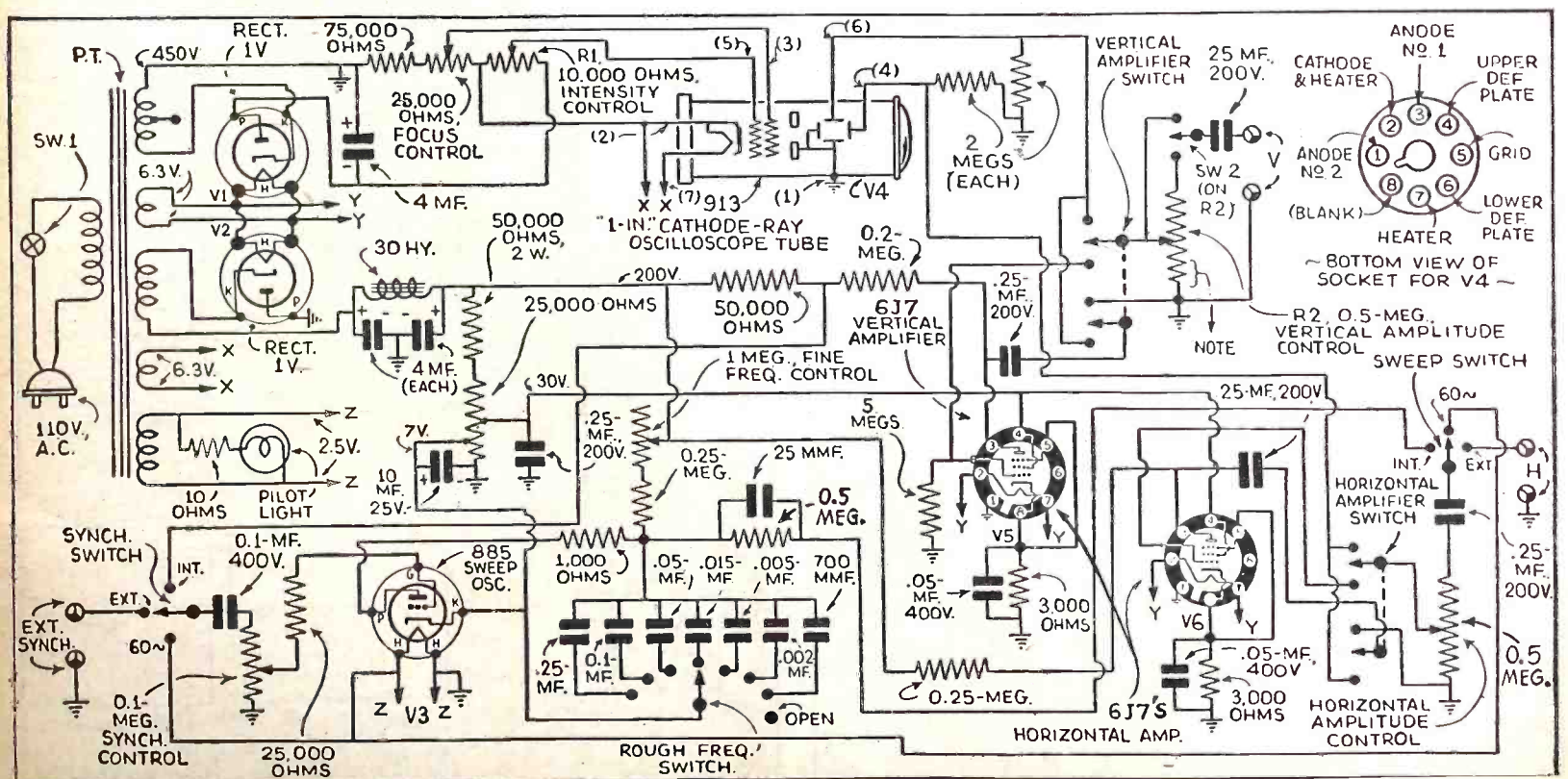

Fig. 2—A troubleshooter's portable oscilloscope, using the 1-inch 913 CR tube. Lettering makes this circuit very easy to follow.

BROADCAST EQUIPMENT

Part X—Modulation Methods and Carrier-Shift Measurement Apparatus

By DON C. HOEFLER

FOR high-quality amplitude modulation, the R.F. carrier must be virtually free of inherent variations in amplitude, such as those which might be due to an insufficiently filtered pulsating D.C. output of a rectifier power supply. The F.C.C. requires that "the carrier hum and extraneous noise . . . level . . . is at least 50 decibels below 100 percent modulation for the frequency band of 150 to 5,000 cycles and at least 40 decibels down outside this range." Furthermore, it is essential that the frequency of the carrier remain exactly at the same point at all times, whether or not modulation is applied. If this condition is not realized, frequency modulation results, which is undesirable in the standard broadcast band, because distortion is introduced and the channel required by the signal is greater. This creates adjacent-channel interference. Frequency modulation of the oscillator would occur if it were not properly isolated from the modulated amplifier. This function is performed by the buffer stage.

For a given carrier strength, the loudness of the sound appearing at the output of a receiver depends upon the amount of variation in the carrier amplitude, which is termed the degree of modulation. It is therefore desirable to maintain the variation in carrier amplitude as nearly maxi-

mum as possible, for the most efficient use of the wave is secured when it is entirely or 100% modulated. Furthermore, heterodyne interference with other carrier waves at remote points is correspondingly reduced.

Fig. 1 explains the meaning of "percentage of modulation." At (A) is shown the unmodulated carrier, whose value is E_1 . When the carrier is being modulated, as at (B) and (C), the amplitude of the wave varies above and below the rest value E_1 . The peak value is E_2 , and the minimum value is E_3 . The ratio of $(E_2 - E_1)$ to E_1 is known as the modulation coefficient (m). By converting the decimal thus obtained, we may express the percentage of modulation (M):

$$\% \text{ Mod.} = M = \frac{(E_2 - E_1)}{E_1} \times 100$$

The outline of the modulated R.F. wave is known as the modulation envelope, and when the modulation coefficient is unity, i.e., when E_2 is twice E_1 , this envelope is varied through the maximum range that is possible without encountering harmonic distortion.

Overmodulation is the condition occurring when the peak modulating power exceeds twice the value of the normal carrier amplitude. Under this condition (shown at

D) there is a period during which the output is entirely cut off, the length of time of cut-off between opposite alternations of the audio voltage being proportional to the degree of over-modulation. Obviously, over-modulation should never be permitted. This is automatically avoided when a limiting-type line amplifier is employed.

The modulation capability of a trans-

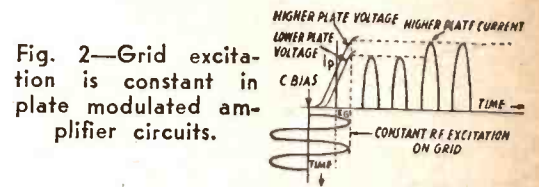

mitter is the maximum percentage of modulation which it can handle without objectionable distortion. In the standard broadcast band, a modulation capability of 85% with not over 10% combined audio harmonics generated by the transmitter is required. However, practically all modern broadcast transmitters are capable of complete modulation with 5% or less harmonic distortion.

PLATE MODULATION

The most widely used system of amplitude modulation in broadcast practice to-

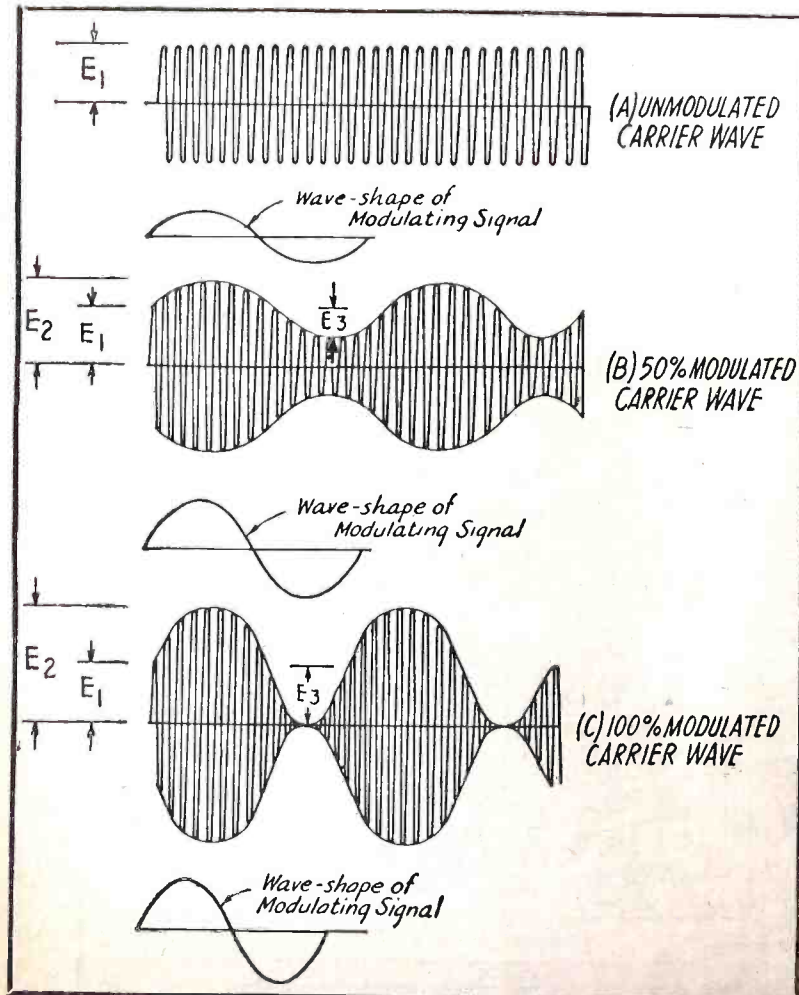

Fig. 1—Modulation patterns for various percentages.

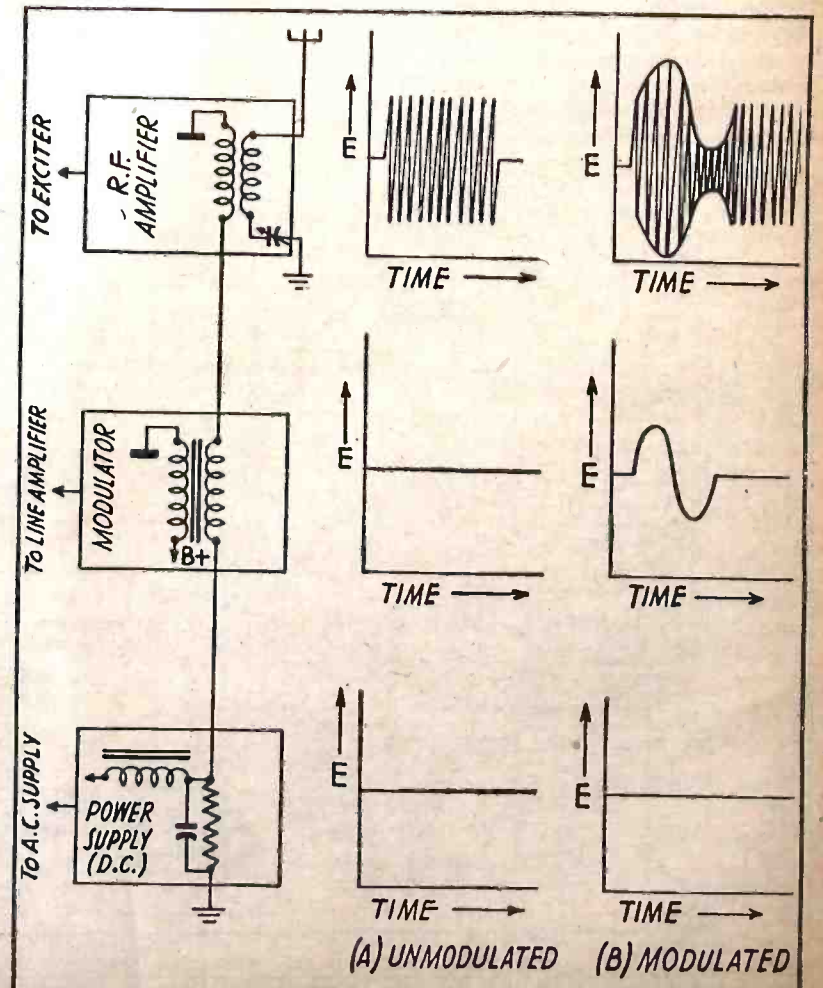

Fig. 3—Plate modulation operation.

day is known as plate modulation. In this method, the R.F. excitation is applied to the grid of the stage to be modulated, just as in the unmodulated stages. The audio modulation voltages are inserted in the plate circuit of the modulated amplifier, in series with the D.C. plate voltage supply. This modulating voltage is usually derived from a power amplifier, termed the modulator, which may be operated class A, class AB, or class B.

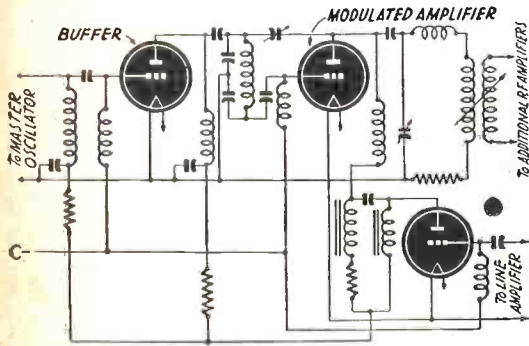

Fig. 4—A typical plate modulated amplifier.

With all other factors constant, the R.F. potential developed in the tank circuit of the final amplifier is proportional to the plate voltage. Since the modulating voltage is in series with the plate supply, the effective voltage on the plate depends upon the amplitude and polarity of the audio voltage. The positive alternation of modulation adds to the plate voltage, and the R.F. output instantly increases in proportion to the sum of the two voltages. On the other half of the cycle, the audio opposes the supply voltage, and the effective voltage at the plate becomes the difference between the two. This is shown graphically in Fig. 2 and schematically in Fig. 3. A Western Electric system of low-level plate modulation employing choke coupling, which is capable of 100% modulation, is illustrated in Fig. 4.

GRID-BIAS MODULATION

In this system, the voltage developed by the modulator is introduced into the grid circuit of the modulated amplifier simultaneously with the R.F. excitation. The audio voltage developed varies the grid bias, which in turn varies the R.F. power output. Plate voltage is constant, and the variation in power output with modulation is accomplished by varying the plate current and plate efficiency. As shown in Fig. 5, the combination of R.F. and A.F. voltages applies to the grid a wave whose form consists of the R.F. excitation swinging back and forth on an axis which varies with the modulation. Thus the resulting plate current is modulated according to the grid voltage variations. The operating efficiency of grid-bias modulation is very low—in practice only about one-fourth the R.F. output is possible from a given tube as compared with plate modulation. The main advantage of grid-bias modulation is that a modulator of much lower power may be employed, one or two watts often being sufficient to operate a modulated tube of considerable power. A typical grid-bias modulation circuit is shown in Fig. 6.

A system which has seen some use in broadcast stations is suppressor-grid modulation. The modulating voltage is intro-

duced into the modulated stage by means of the suppressor grid of a pentode-operated class C. The principle of operation is very similar to that of grid bias modulation. In practice, the circuit is somewhat easier to adjust, since the R.F. and audio are applied to separate grids. Carrier efficiency is about the same, the required modulating power is low, and the tendency toward distortion on the positive modulation peaks is somewhat higher.

The total power in a modulated wave actually comprises two components, the carrier power and the sideband power. Since at 100% modulation the maximum amplitude of the modulated wave is twice that without modulation, when both sidebands are broadcast each sideband must contain one-fourth the total power output. With other factors remaining constant, power varies as the square of the voltage (or current), and thus at the positive modulation peak, the instantaneous power is four times the unmodulated power. Likewise at the negative peak, the instantaneous power is zero. Under sinusoidal conditions of 100% modulation, the average power

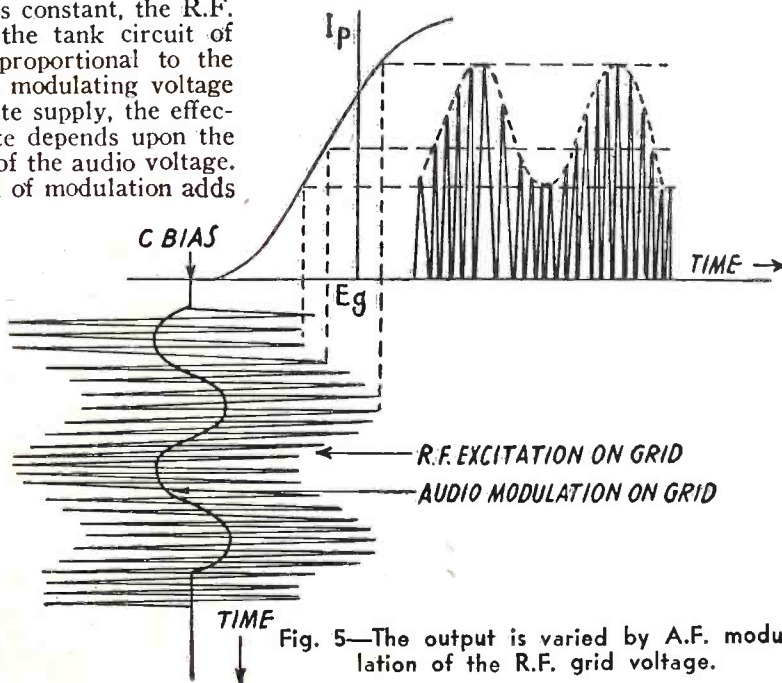

Fig. 5—The output is varied by A.F. modulation of the R.F. grid voltage.

in a modulated wave is $1\frac{1}{2}$ times the unmodulated carrier power. Since the square root of 1.5 is 1.225, the increase in antenna current is 22.5% under these conditions.

CARRIER SHIFT

Carrier shift is a condition occurring when the negative and positive peaks of the modulated wave have unequal amplitudes.

X-RAY RESTRICTIONS LIFTED

RESTRICTIONS on shipments of medical X-ray equipment for civilian purposes by manufacturers have been eliminated through revocation of Limitation Order L-206 on April 27, 1945, the War Production Board said last month. Shipments for military purposes were not restricted by the order.

The types of X-ray equipment affected by the revocation include power units; radiographic, fluoroscopic and therapy tables; photo-fluorographic units; cassette changers; and tube stands.

Revocation of the order does not mean that X-ray equipment will become generally available in the near future, since production of most items requires between six and twelve months. Manufacturers will be able to plan production more efficiently, however, WPB said.

Under L-206, now rendered ineffective, the annual dollar volume of each manufac-

It in no way concerns a variation in carrier frequency. Positive carrier shift occurs when the time average of the positive alternations exceeds that of the negative alternations. In this case the carrier power has

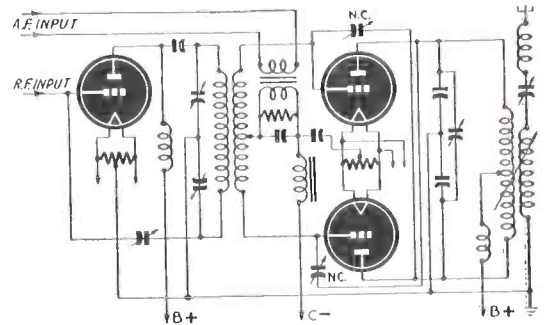

Fig. 6—Circuit of grid-modulated amplifier.

actually shifted upwards. Some of the common causes of this condition are insufficient excitation, excessive bias, improper neutralization, mistuned circuits, and overmodulation. A few tests will suffice to indicate which of these conditions is responsible.

Negative carrier shift occurs when the average value of the power in the transmitted wave has shifted downwards. Some of its causes include excessive excitation, insufficient bias, mistuned circuits, and overmodulation. Carrier shift creates spurious harmonics in the sidebands, resulting in adjacent-channel interference. A very simple portable device for the indication of carrier shift is shown in Fig. 7. The triode is a small 1.5-volt tube connected as a half-wave linear diode rectifier. The coil is coupled to the stage to be monitored and the coupling is so adjusted that the milliammeter deflects to approximately mid-scale without modulation. The pulsating D.C. is smoothed by the condenser-input filter, while the resistance serves to improve the detector linearity. If the needle of the meter remains fixed during modulation, there is no carrier shift present. However, an upward movement of the needle is an indication of positive carrier shift, while a downward movement is an indication of negative carrier shift.

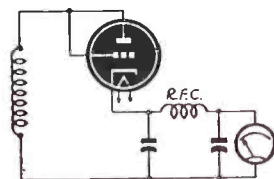

Fig. 7—A simple carrier shift indicator.

Next month we shall discuss the frequency monitor.

turer's shipments of medical X-ray equipment for civilian purposes was permitted to be no greater than 75 per cent of the average annual dollar volume of his shipments in 1937, 1938 and 1939.

Manpower shortage problems were solved in a unique way through cooperation between the Radio Corporation of America and the Prudential Insurance Co. at Newark, New Jersey. Under the plan the radio manufacturer installs a production area on the premises of the other company, and employs office workers part-time. Many of the employees find it easy to put in extra time when relieved of the necessity of journeying to another plant, and are eager to take part in the production of electronic material for the war effort. The plan already provides RCA with 5,000 extra man-hours of new production each week.

The "world's biggest portable" fills fourteen large trailers and requires two others for power supply and one for hauling supplies. Short- and long-wave antennas identify their respective trailers. Receiving station in Trailer 14 may be set up a distance from transmitters, to which it can then be connected by short-wave links, as shown in Sketch 2.

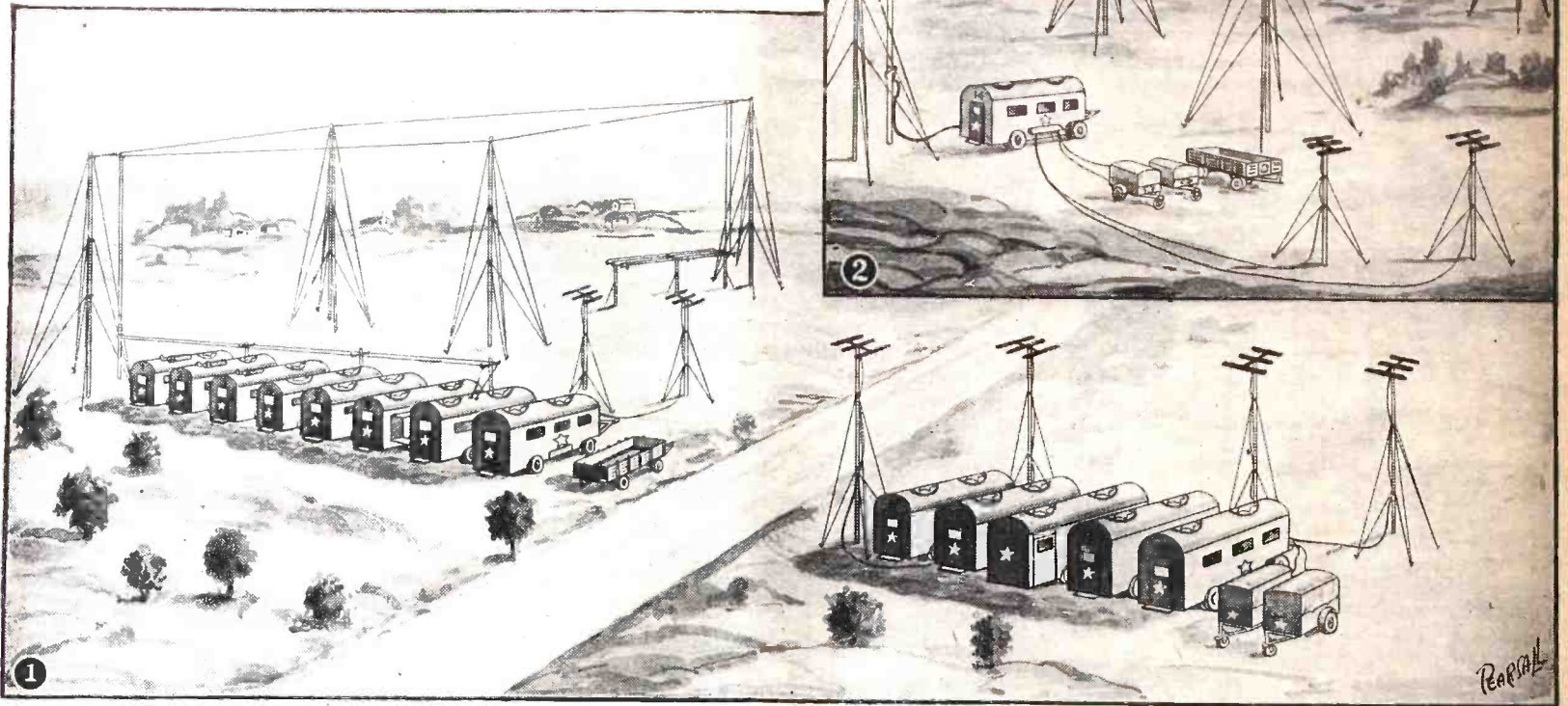

Biggest "Portable" Radio

POSSIBLY the largest mobile radio station ever constructed was developed by the Communications Division of the U.S. Signal Corps Headquarters for use on the West Front in Europe. Completely installed in seventeen large trailers, it has a power of no less than sixty kilowatts—which would be a very respectable figure for a large permanent broadcast station.

The station was capable of transmitting 200,000 words daily across the Atlantic, while sending radioteletypes and photographs at the same time. Simultaneously, it was used as a broadcast station for entertainment of Allied troops within an area of 25 to 30 miles.

Manufactured by the French under Signal Corps supervision, the station can be packed up and moved, or set up and put into action, in little more than 24 hours. In spite of this "portability" it has all the ordinary facilities of a fixed radio station of comparable power, and has its own power plant. It is equipped with broadcast facilities, radio facsimile for transmission of photographs, and the normal, message-handling radioteletype channels. It has equipment for recording on wire, disc, and film.

High-power radio receiving and transmitting stations are usually separated a considerable distance from each other to avoid mutual interference between transmitted and received signals, and ordinarily are connected by telephone lines. With this new mobile radio station, an efficient innovation has been added. The inter-communications between units is by means of special very-high-frequency radio, associated with suitable voice-frequency carrier equipment to provide the required number of keying controls and channels.

Once the radio station convoy has reached a set location, the complete unit can be set up and operating in little more than 24 hours. It can be dismantled and moved with equal facility. The antenna

arrays are supported by 72-foot poles, jointed in eight-foot lengths for convenient transport and erection. An efficient team can erect these poles in 15 or 20 minutes.

All the equipment for the independent operation of the station is ingeniously disposed in the trailers in the following manner: Trailers numbered 1, 2 and 3 each hold a 50-kilowatt Diesel power unit and a 275-gallon fuel tank. A master power switch is attached for converting from

Diesel power to commercial power when the latter is available.

Trailer 4 holds a low tension power supply and voltage regulator, with a 12,000-volt filter condenser. Trailer 5 contains a high-voltage (12,000-volt) DC rectifier unit, 6 has a Western Electric two-kilowatt driver-condenser, very-high-frequency transmitters and receivers, and associated carrier equipment.

Trailer 7 carries a 60-kilowatt power amplifier, which is fed from the transmitter contained in trailer 6, while trailer 8 has an Army Forces Network transmitter, an air blower for the high power air-cooled tubes of the station and a workshop.

The Signal Center is composed of five trailers—numbers nine to thirteen inclusive. Trailer 9 holds supplies and two very-high-frequency transmitter and receiver systems. Trailer 10 contains special carrier equipment. Trailers 11 and 12 have six high-speed teletype machines and associated facilities for handling traffic. Trailer 13 has facsimile transceiver units, the broadcast studio, and a control booth in which space has been set aside for the wire, disc and film recorders. This trailer is also the home of the portable American Forces Network studio.

The receiving station, consisting of one Western Electric receiver, very-high-frequency transmitters and associated carrier equipment, is fitted into trailer 14. Trailers 15 and 16 each hold a 25-kilowatt gasoline power unit, while trailer 17 carries the Army Pictorial Division hut.

The project was executed under Major General W. S. Rumbough, Lynchburg, Virginia, Chief Signal Officer, Communications Zone, European Theater of Operations, and the station is manned by a team composed of personnel selected for their technical proficiency and operating skill. Administrative and guard personnel have been provided to make the team completely independent and self-sustaining.

MEN SWEAR BY IT

By ED CARTER

We offer now to-service men
A hint which we have found
To aid a lot when things begin
To drive US in the ground!

Test instruments are fine, you bet—
We all should own a few;
But if you really fix a set—
It takes some swearing, too!

For instance, take a tune-up job
That throws you way behind;
If just you stop and cuss a bit—
She'll swing right into line!

The intermittents, too, are tough;
They're really little fun.
But if you find the going rough—
Just swear—the job is done!

And that's our tip to service men;
If some sets bring despair—
You'll find it helps you out no end
If you just stop and swear!

(N.B.—Radio-Craft makes no guarantee of, and takes no responsibility for the effectiveness of the service method advocated above by Serviceman and Broadcast Engineer Ed Carter.)

Repairs with Resistors

Correct Use of Radio's Most Common Component

By JACK KING

SECOND only to condensers in their importance to the serviceman are resistors. They were mentioned in last month's article as shunts for electrolytic condensers when connected in series. Resistors present many problems of their own, especially when exact values are not obtainable and the Serviceman must improvise.

For example, resistors add up in ohmic value. A 100,000-ohm resistor in series with a 50,000-ohm resistor gives us 150,000 ohms of resistance. But they do not add up directly in terms of power. We might have a 100,000-ohm resistor and a 50,000-ohm resistor of the same wattage rating connected in series, and watch the 100,000-ohm resistor burn up while the 50,000-ohm unit only becomes slightly warm. A 10-watt 50-ohm resistor connected in series with a 100-ohm

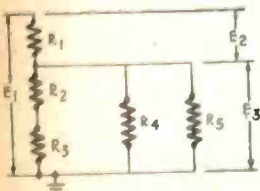

Fig. 1—Typical voltage divider system as used in a radio broadcast receiver.

1-watt resistor would not give you an equivalent 150-ohm 11-watt resistor.

Suppose that an original circuit has a resistor rated at 5 watts and 500 ohms. Let us assume the wattage rating is conservative and equal to twice the actual dissipated power in the circuit, which is common. Then, the power in the resistor is 2.5 watts. The power is related to the current and resistance in the following well known way:

$$P = I^2 R = 2.5 = I^2 500$$

Then,

$$\frac{2.5}{500} = .005 = I^2$$

And,

$$I = \sqrt{.005} = .07 \text{ amp.}$$

The current is the same in all parts of a series circuit. This means: Whatever the relative wattages of the two resistors in series may be, each must be capable of passing .07 ampere without burning up. It

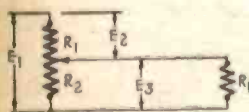

Fig. 2—This divider circuit appears in many radio circuits.

would be possible to use two 250-ohm resistors rated at 2.5 watts each, to give 500 ohms rated at 5 watts. Would a 200-ohm 10-watt resistor and a 300-ohm 1-watt resistor serve in place of the 500-ohm 5-watt unit? The series current will be the same as in the original case because the resistances are identical. Then,

$$P_1 = I^2 R_1 = .07 \times .07 \times 300 = 1.5$$

$$P_2 = I^2 R_2 = .07 \times .07 \times 200 = 1$$

(Round off .07 × .07 to .005)

The answer is no, since the 300-ohm unit is rated at 1 watt and is called upon to dissipate 1.5 watt. Some other combination would be necessary.

It would be possible to work out a solution by using a parallel combination. As an example, two 1,000-ohm resistors in parallel give a net resistance of 500 ohms. If each of the resistors are rated at 2.5 watts the power handling ability is 5 watts. Knowing the voltage across a resistor, the power in the resistor can be figured using the formula:

$$P = \frac{E^2}{R}$$

OPEN VOLTAGE DIVIDER SECTION

In some cases a section of the voltage divider in a receiver will "go." It is generally not necessary to replace the entire voltage divider, but merely to shunt the open section with an appropriate resistor. Fig. 1 shows a typical voltage divider system. If the original resistances are known, the problem of a replacement is simplified. Suppose R1 is burned out, but R2 and R3 are all right. The resistances R4 and R5 are tube resistances—assume they are screen grid-ground resistances. Usually, when the diagram is available, the manufacturer gives the resistance values, but often the wattage ratings of the individual sections are not given. A 50-watt resistor

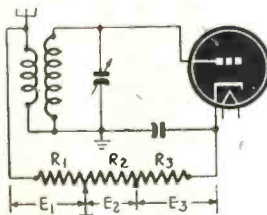

Fig. 3—The volume control on many old radios is a divider between the cathode and antenna circuits.

rated at 20,000 ohms and equipped with an adjustable slider can be used for test purposes. The resistance is adjusted until correct operating voltages are secured. The power in the resistor is then figured, using the power formula previously given (P equals E squared over R). The wattage rating for the resistor is taken as twice the actual measured power. Then it will run cool and not overheat.

The same experimental procedure can be used when the resistance values are not known, but on some occasions, because you don't have the test resistor available, or for other reasons, it may be necessary to figure the current through R1 and the power. With the receiver power turned off, R4 and R5 are in effect open. The resistances of R2 and R3 are the two added. If the original voltage E_1 is known, or assumed, the current through R1 is the same as the current through R2 and R3. The voltage E_3 is known. Then,

$$E_2 = E_1 - E_3$$

In a typical case, E_1 would be 300 volts, E_3 , 100. Then E_2 is 300 - 100 or 200 volts. The currents taken by the screen grids at 100 volts could be estimated by reference to a tube manual. The current through R1 due to E_1 acting in series with R1, R2 and R3, is:

$$I_1 = \frac{E_1}{R_1 + R_2 + R_3}$$

For simplicity, no tap is shown at the junction of R2 and R3, but the principles of analysis would be the same in any case. The current of the screen grids is:

$$I_2 = \frac{E_3}{\left(\frac{R_4 \times R_5}{R_4 + R_5} \right)}$$

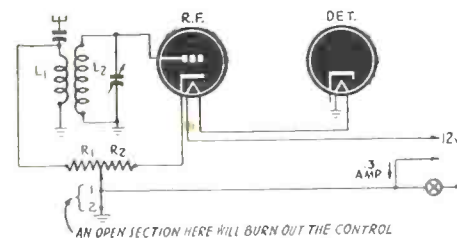

Fig. 4—A possible cause of control trouble.

The total current through R1 is:

$$I_T = I_1 + I_2$$

Assume, for example, the screen grids draw a total of 5 milliamperes at 100 volts. The voltage E_1 is 300 volts. Further, assume R2 is 4,000 ohms and R3 is 1000 ohms. The total resistance of the voltage divider is:

$$R_T = R_1 + R_2 + R_3$$

If the voltage across R2 and R3 in series is 100 volts and the resistance is 5,000 ohms totally,

$$I_1 = \frac{E_2}{R_2 + R_3} = \frac{100}{5000} = .02 \text{ amps.}$$

The current of the screen grids, I_2 is added to obtain I_T .

$$I_T = I_1 + I_2 = .02 + .005 = .025 \text{ amps.}$$

The voltage across R1 is E_2 , 200 volts, and

$$R_1 = \frac{E_2}{I_T} = \frac{200}{.025} = 8000 \text{ ohms}$$

The power rating of R1 is:

$$200 \times .025 \times 2 = 10 \text{ watts}$$

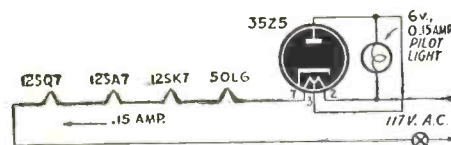
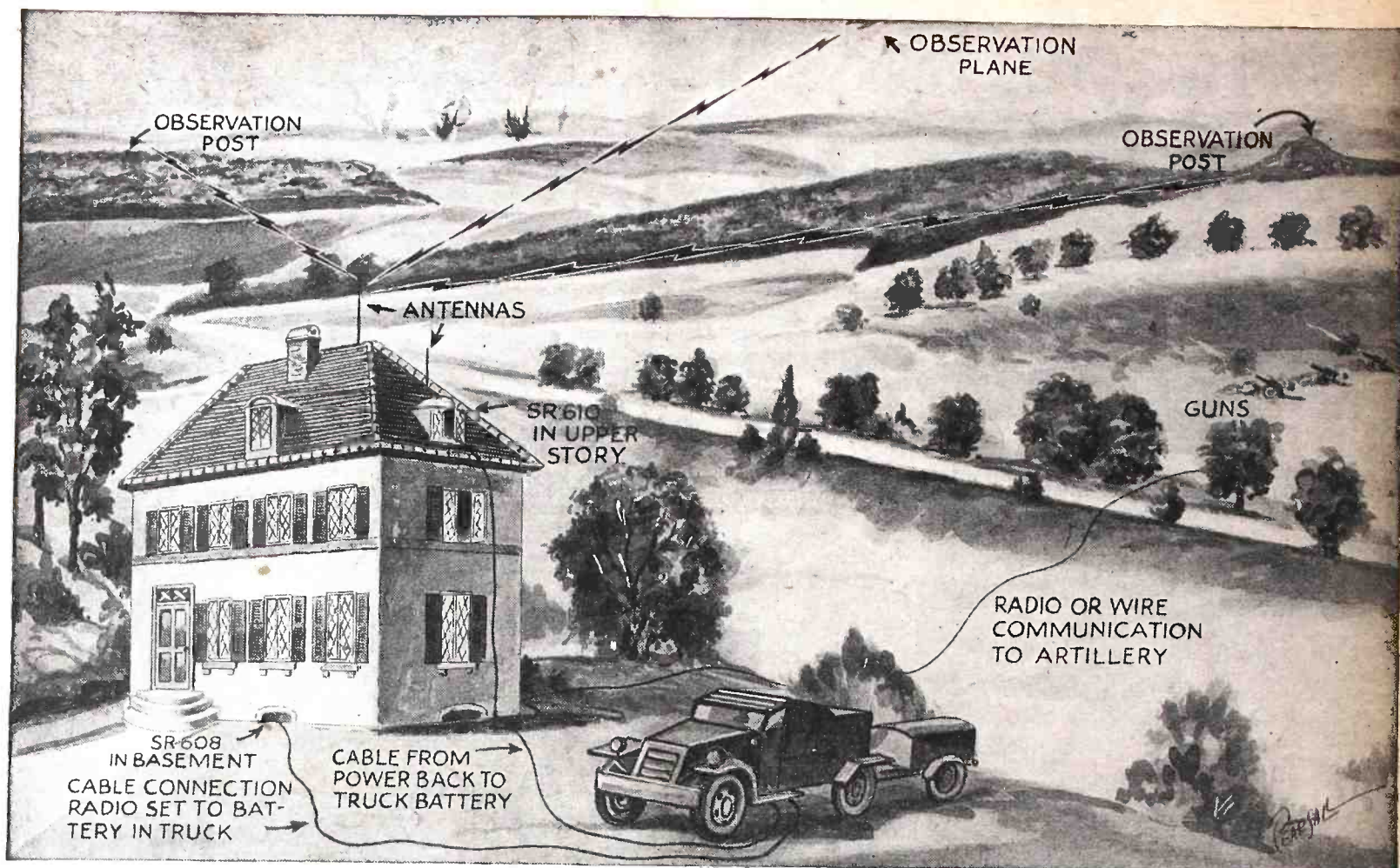

Fig. 5—Standard A.C.-D.C. heater circuit.

THE AUDIO POTENTIOMETER

Another form of voltage divider is the ordinary audio potentiometer shown in Fig. 2. The input voltage is E_1 , and the drop across the upper section R1 is E_2 ; the drop across the lower section R2 is E_3 . The voltage across R2 is the same as the voltage across R_L . The current at the junction of R1 and R2 divides between R2 and R_L according to the ratio of R_L to R2, as R_L is often larger than R2. The current in the potentiometer will usually be small.

(Continued on page 660)



Fixed-station conditions extended the range of standard Army mobile radios. Observation planes were often used also as relay stations.

BATTLE RADIO TRICKS

"NECESSITY is the mother of invention—but War is its father," said a prominent scientist during the last World War. Even he would no doubt have been astounded at our present War of Science, with its radar, robots and rockets. Not only in the research laboratory, but down to the lowliest private, has inventive ingenuity been stimulated. This war, so unlike any other in its tactics of mechanized motion, infiltration and airborne invasion, has posed problems which had to be settled on the spot, without help from past experience.

The radioman has been compelled to learn faster and to react more quickly than his comrades in any other branch of the service. The unparalleled dependence upon communications demanded by the special struggles of this war has been matched only by the diversity of new and previously unknown types of communications equipment sprung upon him. He has been compelled to juggle with frequencies hardly considered usable before the struggle began, and has put to use transmitters and receivers, based on FM, previously used only in the broadcast field, and not too widely there. Unexpected conditions arising on the field of battle have had to be solved on the spot—and immediately—if the signalman and his comrades were to survive. According to Capt. George Sammet, Jr., writing in the *Field Artillery Journal*, communication procedure advances to a new high in combat action, "in the first month and at a pace that is remarkable," even after years of training in the States have brought it to a high state of perfection. Not that methods of training were outmoded and insufficient, he says, but that mistakes which

seemed trivial on maneuvers are magnified a hundredfold when a lost word or a mixed-up fire order may mean the lives of many doughboys.

Technical advances must keep up with operating skill, when problems of range, terrain, or interference make communication impossible at a time when impossibilities simply cannot be admitted. In such situations a corporal or sergeant is inspired to "delve into a situation and come up with answers which back home he would never have thought himself capable of." But let Captain Sammet tell his own story of American ingenuity under battle conditions:

COMBAT RADIO IMPROVEMENTS

The old method of handling fire direction was to set up three SCR-610 radios in the vicinity of Fire Direction Center, then—when the radios of liaison officers and forward observers were almost out of range—to send out a relay station. This method proved very inefficient, as it took a large number of operators. All calls had to go through the relay station, thus increasing the time of fire missions and introducing one more chance of error in transmission; also, the only protection the operator had was his foxhole. Where a 608 radio was used for a relay the operator had to stay in the command car, and when enemy artillery shells begin falling a command car is a very undesirable place to be.

We took an SCR-608 radio out of a command car, put it in the cellar or a lower-floor room of a house, and ran cable through the window to the battery terminal box in the command car, which was

sometimes up to 40 feet away. A 5-section antenna was put up on the roof and connected to the antenna terminal on the radio by a 40-foot length of ordinary electric light cord that was found in the vicinity (any good electric light wire with a large copper core will do the job). We had been told back in training that to increase the lead to the antenna would decrease the efficiency of the set—but by using this set-up we increased the reception and transmission of the 608 radio so much that we eliminated the need of a relay station except in few instances. Further, the basement location gave a more adequate protection to the operator and consequently increased his efficiency.

The SCR-608 took the place of two of the base sets. For the third we used an SCR-610, which was placed in the top floor of the building with its regular antenna sticking out of the roof. We found that we could not use a long antenna lead to this radio, as we could to the SCR-608, as this decreased its efficiency considerably and there are no means of compensating for the loss as in the case of the SCR-608. We were able to run a cable from the SCR-610's power pack to the vehicle battery terminals some 60 or 80 feet away, thus permitting us to avoid using a battery pack. The main disadvantage of the set-up was the necessity of keeping an operator on the top floor, which is by no means safe and is considered foolhardy except in the case of observers who must sacrifice safety for observation.

The cable from the microphone to the radio consists of two circuits, the transmitting circuit of three wires and the receiving circuit of two. By using five strands of

(Continued on page 663)

VITAMIN-Q

REG. U. S. PAT. OFF.



Ever Hear of It?

VITAMIN Q is an exclusive Sprague Electric Co. oil impregnant for capacitors that results in exceptional performance where thousands of volts and temperatures as high as 105° C. or as low as -40° C. are involved. Leakage resistance at room temperature is 20,000 megohms for one microfarad—or at least 5 times better than previous types!

This is only one of the many engineering and production achievements that have helped make Sprague a five-time winner of the coveted Army-Navy "E" award. And it is one that indicates plainer than mere words that, as always,

you can rely on Sprague for the finest, most modern engineering in ANY capacitor type for radio service, amateur or experimental work.

ATTENTION TRADING POST USERS!

Our free wartime advertising service, THE SPRAGUE TRADING POST, will be found on another page in this issue. It will continue as long as there is a need for this unique method of selling or buying hard-to-get radio things.

SPRAGUE PRODUCTS COMPANY
North Adams, Mass.

(Jobber Sales Organization for Products of the Sprague Electric Co.)



SPRAGUE

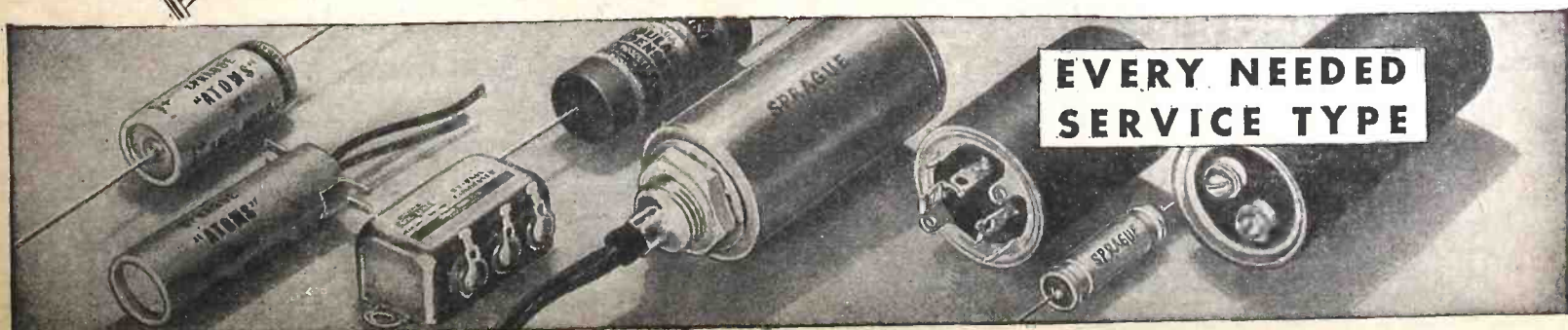

**EVERY NEEDED
SERVICE TYPE**

HOW TO "TEST" A RADIO IN 2 MINUTES

Want to repair radios—without months of specialized service training? Or, if you are already a radio serviceman, do you want to learn how to diagnose troubles in 2 minutes or less and fix most sets TWICE AS FAST and TWICE AS PROFITABLY without unnecessary testing? Then order Ghirardi's RADIO TROUBLESHOOTER'S HANDBOOK today. See opposite page for description—USE COUPON AT BOTTOM.

SAVE MONEY ON THIS SPECIAL OFFER

Have a complete Radio-Electronic Service Library at your fingertips! Know how to work fast—and work right. Have complete reference data on test instruments, trouble-shooting and repair so that you can quickly look up any type of work that may puzzle you. Stop waste time—lost motion. Make more money! Get both Ghirardi's RADIO TROUBLESHOOTER'S HANDBOOK and his MODERN RADIO SERVICING at the special bargain price of only \$9.50 (\$10.50 foreign) FOR THE TWO BIG BOOKS. See Money Saving Combination in coupon on opposite page.

JUST OUT!

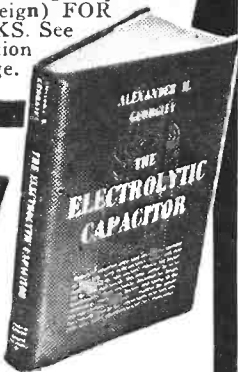

AN IMPORTANT NEW BOOK ON A LITTLE KNOWN SUBJECT

Don't buy, specify, use, or replace Capacitors blindfolded! Save time, save money, and increase your service efficiency by really knowing all about this vital subject! Actually, no Radio-Electronic component is more important or less understood than the Electrolytic Capacitor. Postwar equipment will employ more of them—and in new, improved types. This new book by Alexander M. Georgiev for more than 15 years a leader in Capacitor research and development, at last explains the entire subject. Answers all the many questions servicemen, engineers, and designers have been asking about capacitors for years.

ENDORSED by A. A. GHIRARDI

"I heartily recommend The Electrolytic Capacitor as 'must' reading for the man who really wants to forge ahead in post-war Radio-Electronics", states A. A. Ghirardi, internationally famous technical author. "It tells what types to use and where and how to use them to best advantage—explains the advantages and disadvantages of each—how to make emergency repairs and a host of other subjects invaluable to the man who KNOWS it pays to KNOW." Contains over 200 pages and eighty illustrations. Price only \$3 (\$3.25 foreign).

USE COUPON ON OPPOSITE PAGE

Midget Amplifier

By W. A. RIEVELY

A CUSTOMER of mine living on a nearby mountain wished to have his Victrola made to play through an amplifier and loud-speaker, using a crystal-pickup of fair quality. He asked that the complete outfit be housed in the original Victrola cabinet, including the heavy duty batteries. After fitting the 6-inch speaker and batteries into the cabinet I found that I had a space 6 x 8 inches left. The midget amplifier was designed for this space.

I used a chassis I had which is 5 x 6 x 2 inches in dimension. This space would only allow me to use 2 tubes and the output transformer. I punched the two socket holes in the top of the chassis two holes for the controls in the front, one hole in back for the phono jack and one for the battery cable. All parts are mounted in the chassis including a 6-terminal soldering lug strip which is mounted between the two sockets, running from the front of chassis to the back.

With a list of battery tubes on hand and a tube manual I checked tube against tube and decided to use a pair of 1D8-GT's in a phase-inverter circuit with the triodes as drivers and the pentodes in push-pull. This is a circuit with excellent output and quality. The phase-inverter circuit saves the price and space of an input transformer and gives better quality. By studying the circuit diagram for a minute its action will become

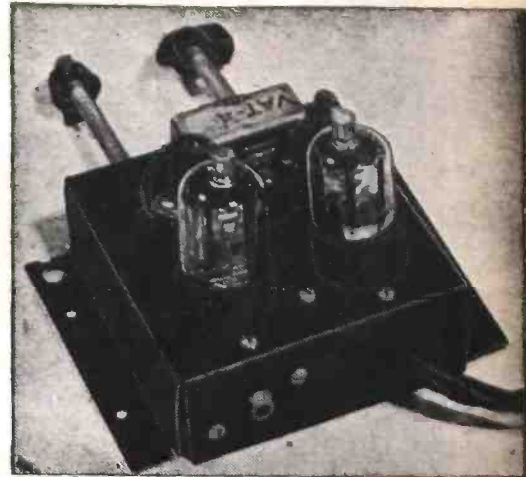

quite clear to any serviceman or experienced constructor. lugs on the sockets are used as wiring tie points. Parts that are not wired to socket lugs are wired to the six-point terminal strip. In this way all parts are mounted firmly in the chassis. Every part was checked and double checked before soldering it in place. Thus I was sure I would not have to tear the thing apart due to a defective part or wrong connection. The triode and pentode sections are shown as separate tubes in the diagram although both sections are in the same envelope of the 1D8-GT. To show both sections in the same envelope in the drawing would make the circuit appear complicated. Socket lug num-

An interesting combination of inverter circuits marks this amplifier. A number of extra condensers maintain stability.

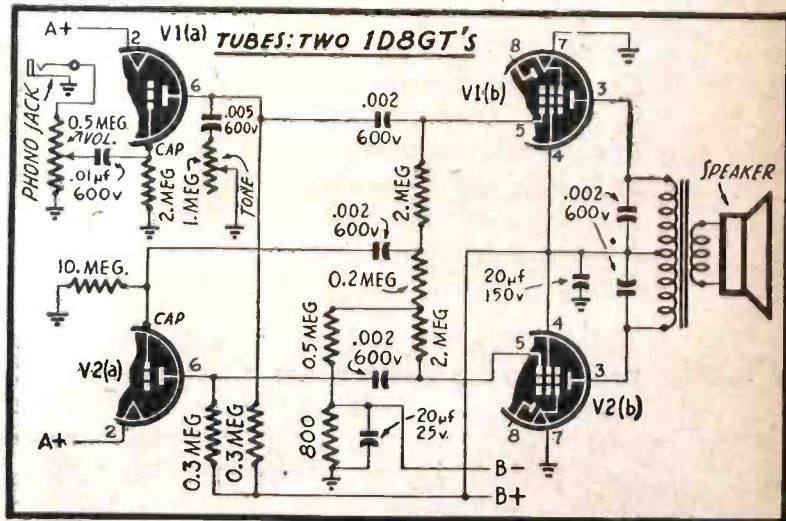

quite clear to any serviceman or experienced constructor.

Some may think that wiring up the parts in such a small chassis would be difficult. It is really quite simple. I wired the heater and screen-grid circuits first. I then wired parts that had both connections on the same socket, such as coupling condensers, by-pass condensers and grid resistors. Unused socket

bers are shown to simplify the wiring. Anyone with any wiring experience at all should have no trouble in hooking up this unit from the diagram and photo.

This job does not do the miraculous, but will be found to have plenty of volume for a large room. In fact it will give the same output as a large battery radio. It more than satisfied my customer.

"TELEDIAGNOSIS" BY MARINE RADIOPHONE

"Medico" is the well-known signal of the marine radio operator seeking doctor's advice for sick or injured men aboard his ship. The term was given a wider significance "somewhere in the Pacific" recently when the use of phone brought the distant doctor to the stricken seaman's bunkside.

The patient, victim of a heart attack, required diagnosis not readily available

from the information which could be supplied by the ship's crew, untrained in medical science. A microphone was therefore rigged up to catch the sounds from a stethoscope held over the patient's heart. Listening to the heartbeat at the shore station in Honolulu, the "medico" was able to prescribe successfully, and the seaman was safely landed several days later.

WE'LL "LEND" YOU ANY OF THESE 3 GREAT BOOKS *for* 5 FULL DAYS

Every Cent of Your Money Cheerfully Refunded
if You're Not More Than Satisfied

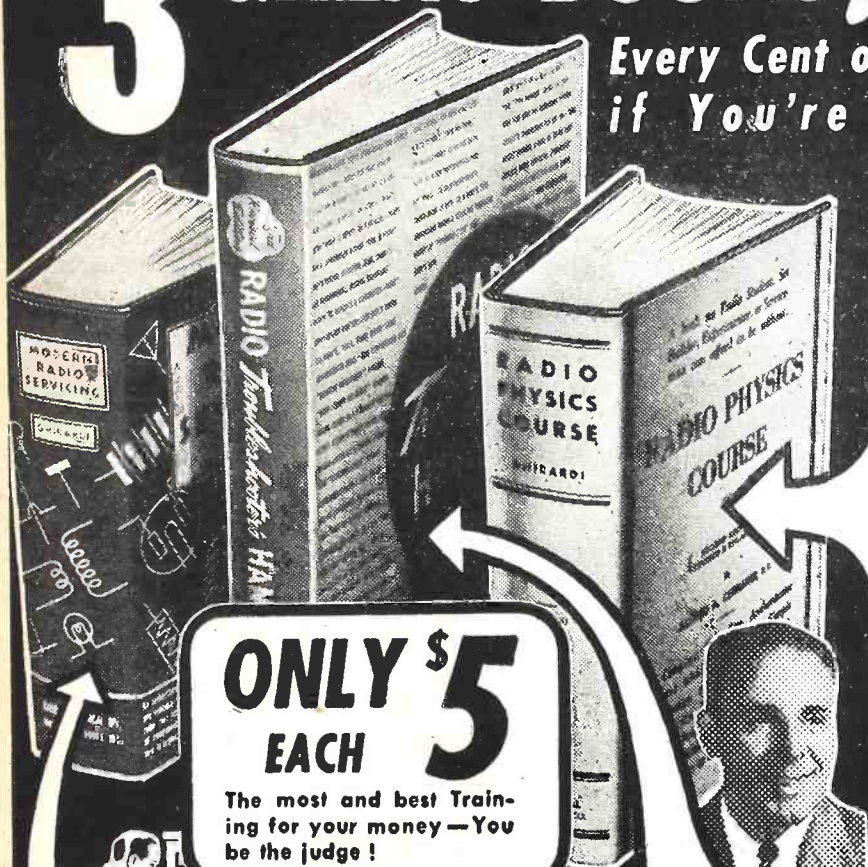

**ONLY \$5
EACH**

The most and best Training
for your money — You
be the judge!

Get a better job — start a
business of your own in
fascinating Radio-Electronics!

LEARN PROFESSIONAL SERVICING WORK at home

A. A. Ghirardi's big, 1300-page MODERN RADIO SERVICING is the finest, most complete instruction course on Radio-Electronic service work for either the novice or professional serviceman—bar none! Ask anyone in the business! Read from the beginning, it is a COMPLETE COURSE IN SERVICING by the most modern methods. Used for reference, it is an invaluable means of brushing up on any servicing problems that puzzle you.

COMPLETE DETAILS ON TEST INSTRUMENTS, TROUBLESHOOTING, REPAIR

Gives complete information on all types of test instruments; how they work (with wiring diagrams); When, How and Why to use them; how to build your own; preliminary trouble checks; circuits and parts analysis; parts repair, replacement, substitution; obscure troubles; aligning and neutralizing—and hundreds of other subjects including How to Start Your Own Successful Radio-Electronic Service Business. 706 self-testing review questions help you check your progress every step of the way. 706 illustrations and diagrams. \$5 complete (\$5.50 foreign). 5-DAY MONEY-BACK GUARANTEE. See our Money-Saving Combination Offer in coupon.

ALL THE SCIENCE OF BASIC RADIO-ELECTRONICS in one big 3½ lb. Book

For Beginners—36 Courses in One

Here is the big book that makes it easy for beginners to start in the fascinating field of Radio-Electronics! Actually, A. A. Ghirardi's 972-page RADIO PHYSICS COURSE book gives you just the basic training you need—ALL YOU NEED — easier, better, faster—for ONLY \$5 COMPLETE. Actually, this giant book is 36 courses in one. If sold in monthly lessons, you'd regard it as a BARGAIN AT \$50 OR MORE!

You'll be surprised how easily RADIO PHYSICS COURSE helps you master subjects that other courses make seem very complicated.

You'll be delighted how soon it will have you doing experiments, building equipment, etc. Step by step it carries you from the very beginning through Basic Electricity to the most modern Radio-Electronic developments. Hundreds of readers have completed it in a few weeks. All you need is a little reading time plus a desire to get started now for a better paying future in broadcasting, aviation radio, F.M. Television, radio servicing, manufacturing — or other fast-growing Radio-Electronic branches. 5-DAY UNRESERVED MONEY-BACK GUARANTEE!

Radio's Greatest Training Buy!

THIS AUTOMATIC TEACHER SHOWS EXACTLY HOW TO REPAIR OVER 4,800 DIFFERENT MODELS!

Ghirardi's big RADIO TROUBLESHOOTER'S HANDBOOK is the ideal manual to show you exactly how to repair radios quickly, without a lot of previous experience and without costly equipment. This 744-page manual-size HANDBOOK brings you specific repair data for the common faults that account for almost 90% of ALL troubles in practically every radio in use today! You don't study it. Simply look up the make, model, and trouble symptom of the Radio you want to repair. No lost time! Clear instructions tell you exactly what the trouble is likely to be, exactly how to fix it.

Specific instructions cover over 4,800 of the most popular models of Home and Auto-radio receivers and Automatic Radio Changers of 202 manufacturers!

Also, RADIO TROUBLESHOOTER'S HANDBOOK has hundreds of additional pages of repair charts, tube charts, data on tuning alignment, transformer troubles, tube and parts substitution, etc., etc., all designed to help you repair all makes and models of radios, faster, and more profitably! Only \$5 (\$5.50 foreign). FIVE DAY UNRESERVED MONEY-BACK GUARANTEE!

Make Money in Your Spare Time!

5-DAY MONEY-BACK GUARANTEE

Technical Division, MURRAY HILL BOOKS, Inc.,
Dept. RC-75, 232 Madison Ave., New York 16, N. Y.

Enclosed find \$..... for books checked; or send C.O.D. (in U.S.A. only) for this amount plus postage. If not fully satisfied, I may return the books within 5 days and receive my money back.

RADIO PHYSICS COURSE. \$5 (\$5.50 foreign) RADIO TROUBLESHOOTER'S HANDBOOK. \$5 (\$5.50 foreign).

THE ELECTROLYTIC CAPACITOR. (See column on opposite page.) \$3.00 (\$3.25 foreign) MODERN RADIO SERVICING. \$5 (\$5.50 foreign).

MONEY-SAVING COMBINATION: MODERN RADIO SERVICING and RADIO TROUBLESHOOTER'S HANDBOOK (both books) only \$9.50 (\$10.50 foreign).

Name

Address

City & Dist. No. State

TRAIN NOW FOR THE BEST OF ALL POSTWAR INDUSTRIES

RADIO FILTER CIRCUITS

THE simplest filter consists of nothing more than a series condenser. This is shown in Fig. 1. The load R_L might be that of an output meter used in the alignment of a radio receiver, connected between the plate of an output tube and B—.

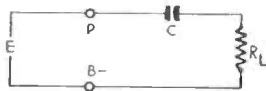

Fig. 1—The simplest type of filter circuit.

The series condenser prevents D.C. from getting into the meter circuit. The signal voltage from plate to ground on the output tube might only be 10 or 20 volts, while the D.C. plate voltage might well be 250 or higher. The condenser filters out the D.C. and allows the A.C. to pass, which is one of the simplest filtering actions that can be visualized.

Suppose we wish to pass, for the most part, a definite frequency. To the condenser we can add a coil which will give us series resonance. This is shown in Fig. 2. When



Fig. 2—The common series-resonant hookup.

the reactance of the inductor is equal to the reactance of the capacitor, the net reactance is zero and we have resonance. Suppose that L and C are adjusted to resonate at 400 cycles, which is the modulation frequency of many signal generators used in practical radio servicing work. Then the output meter will respond primarily to the 400-cycle note and not so much to 800 or some other frequency, giving in effect an increase in the sensitivity at 400 cycles.

This same series resonant circuit, may be used in the antenna circuits of radio receivers of the superheterodyne type. The I.F. frequencies of such sets may be close to the transmitting frequencies of local weather stations and code stations. By means of L and C , as shown in Fig. 3, we

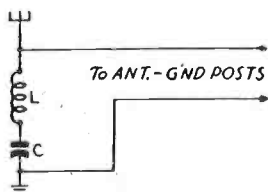

Fig. 3—Series resonance in wavetrapp filter.

can filter out the unwanted signal. This series combination is most effective as a filter when the input impedance of the radio is high. If the input impedance is low, a circuit of the type shown in Fig. 4 is more effective.

Referring to Fig. 3, the wavetrapp filter has a low impedance at the resonant frequency. Therefore, the signal current at the intermediate frequency of the radio is safely shunted around the input terminals of the radio to ground, and kept out of the I.F. system. If the input impedance of the radio is large, and the impedance of the wavetrapp filter is low, the signal current will divide in proportion to the relative impedances and little signal current at the I.F. will get into the radio from the antenna. In cases where the radio's input impedance is low, the circuit of Fig. 4 is more effective

By JOHN KEARNEY

as a filter. At resonance, this circuit is in effect a very high resistive impedance between terminals 1 and 2, limiting signal current flow at the I.F. value. An R.F. voltage appears between terminal 1 and ground. The impedance of the filter is in series with that of the set. Even though the set's impedance is high, the impedance of the parallel L - C combination will be much higher at resonance, so that relatively little interfering I.F. voltage is left between terminal 2 and ground.

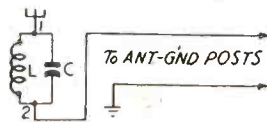

Fig. 4—Parallel-resonant (rejector) filter.

In the preceding examples, simple combinations of L and C have been used for filtering. More elaborate circuits can be used. In considering some of them, let us recall two important facts:

1. The reactance of a condenser decreases with frequency.
2. The reactance of a coil rises with frequency.

In Fig. 5, another basic circuit is shown. This circuit will reject high frequencies so far as the load R_L is concerned. C shunts the high frequency signals around the load, while L offers a high series impedance to the flow of the higher frequency signal cur-

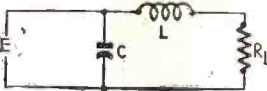

Fig. 5—Low-pass filters are common in radio.

rents. The lower frequency signals will not be attenuated to any considerable degree because the reactance of C is high at low frequencies and the reactance of L is low. If L and C resonate, there is a tendency to cause a large circulating current in R_L , but usually R_L is fairly large and the circuit Q is low, so that resonance is not troublesome. If R_L is low, the circuit is in effect a combination of L and C in parallel.

We can get a simple high-pass filter by using the circuit shown in Fig. 6. The low-frequency current is readily shunted around the load by the choke coil, while the series condenser has a low reactance at high frequencies and a high reactance at low frequencies, both effects working together to filter out the lows and pass the highs, so that the arrangement is in effect a "high-pass filter."



Fig. 6—Filter for passing high frequencies.

If we have a ripple voltage, as in a power supply, appearing across C in Fig. 5, we can cut down on the ripple voltage appearing across the load by shunting an additional

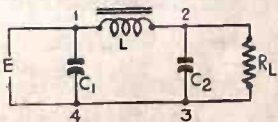

Fig. 7—Low-pass filter used in power packs.

condenser across it, as shown in Fig. 7. In this circuit, we can make L have a high reactance at the lowest frequency to be

filtered, say 60 cycles or 120 cycles. In a half-wave rectifier, the output frequency is 60 cycles for the fundamental and the 120-cycle figure is encountered in balanced full-wave rectifier circuits. If L is large in in-

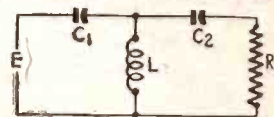

Fig. 8—The high-pass "T" filter circuit.

ductive reactance at the fundamental, its reactance will be still larger for the harmonics, and the second and third harmonics will be important in any power supply. As the frequency rises, the effectiveness of the condensers increases, since X_C drops with f .

Fundamentally the same filter can be used in high-fidelity radios where both tweeter and woofer speakers are working together, the woofer using a low pass and the tweeter a high-pass filter.

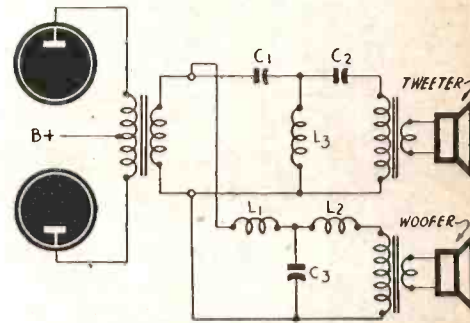

Fig. 9—Filters used in cross-over network.

The high-pass filter is shown in Fig. 8. This is a more elaborate high-pass filter than the simple type shown in Fig. 1 and Fig. 6. The combination of the two filters in the circuit of an FM radio with extended frequency range, is shown in Fig. 9. In this figure, C_3 does not shunt the input to the tweeter (which would make getting high frequency signal energy into it difficult) because of the limiting effect of series element L_1 .

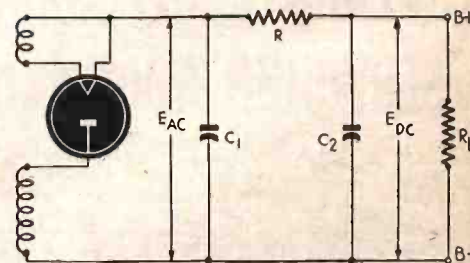

Fig. 10—Resistance-capacity filter circuit.

In the circuits shown, reactances having low resistances and therefore small power dissipation, have been employed. In many places, however, we find that R - C filters are used in radio circuits. One of these is the low-current filter circuit of a high voltage cathode-ray oscilloscope, where the current from the power supply is low and, therefore, the IR drop in the series resistance is of no great importance. A filter of this type is shown in Fig. 10.

Here, the A.C. ripple across the load R_L is held to a low value by means of C_1 , R and C_2 . The half-wave rectifier has a high voltage output, consisting of a D.C. value plus a superimposed A.C. value that has an irregular wave shape and consists of a fundamental plus a lot of harmonics, chiefly the second and third. The A.C. prefers the easy

(Continued on page 655)

SYLVANIA NEWS

RADIO SERVICE EDITION

JULY Published by SYLVANIA ELECTRIC PRODUCTS INC., Emporium, Pa. 1945



As another service to servicemen, and in further support of Sylvania's big advertising campaign designed to broaden the postwar radio market, Sylvania Electric is widely distributing to the public the new booklet "They Know What They Want."

In it the radio serviceman will find the answers to questions concerning Television, F.M., how many people are planning to buy new radios after the war, and many more — giving him a variety of pertinent facts that are bound to bear directly upon his future welfare.

In addition, "They Know What They Want" is being widely circulated to consumers in response to inquiries stimulated by the questionnaire-type advertisements appearing in national magazines — advertisements through which Sylvania Electric is continuing its study of public preferences in radio. This general distribution is expected to maintain popular interest in postwar radio sets — an interest that will gradually influence the number of sets that will need servicing in the postwar years to come.

Send for your copy now.

NEW BOOKLET SUMMARIZES AND STIMULATES POSTWAR RADIO MARKET

Servicemen Can Obtain Helpful Information On National Radio Trends

Here is a booklet that gives a handy summary of the public's postwar radio wants—a result of Sylvania's nationwide survey and questionnaire-type advertisements. Copies for servicemen are available on request—*Sylvania Electric Products Inc., Emporium, Pa.*

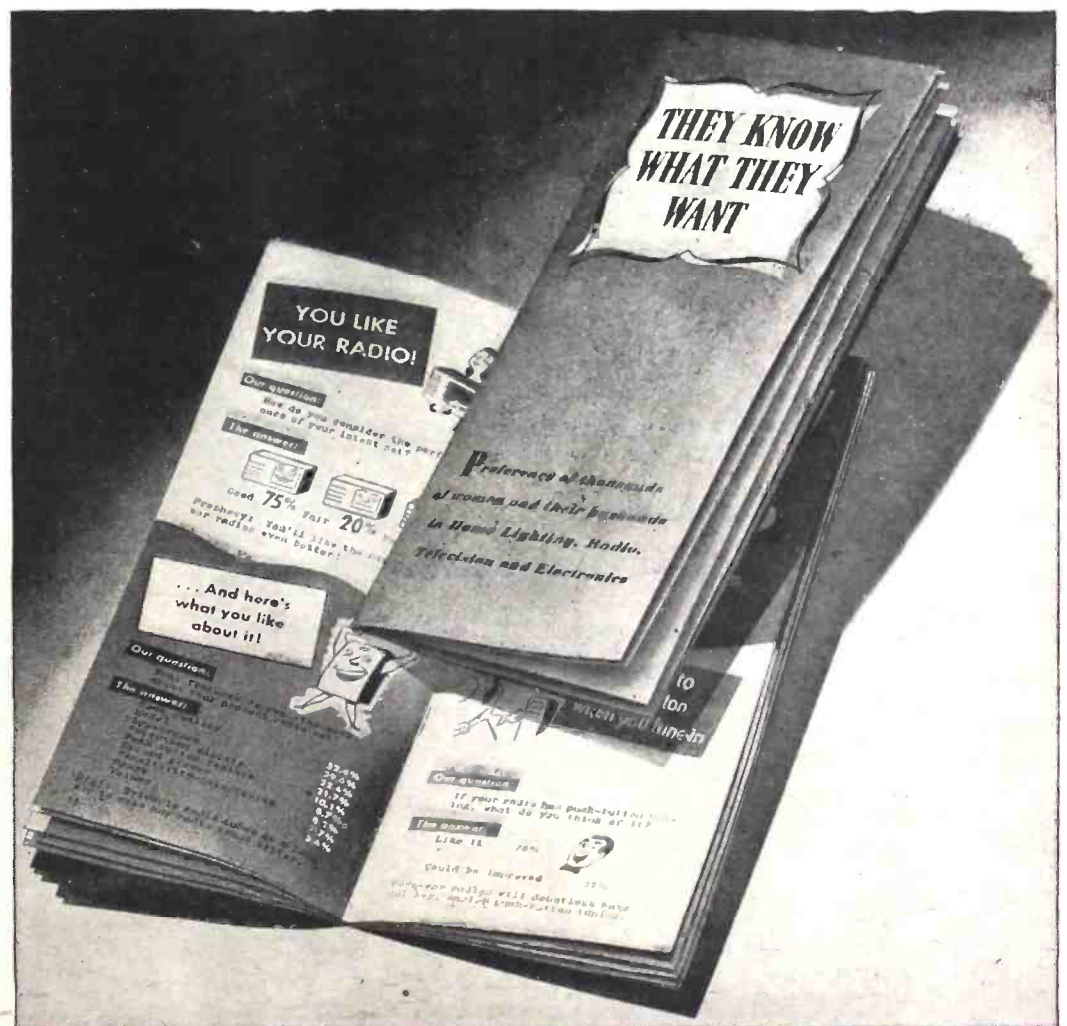

SYLVANIA ELECTRIC

Emporium, Pa.

MAKERS OF RADIO TUBES: CATHODE RAY TUBES: ELECTRONIC DEVICES: FLUORESCENT LAMPS, FIXTURES, ACCESSORIES: ELECTRIC LIGHT BULBS
RADIO-CRAFT for JULY, 1945

World-Wide Station List

Edited by ELMER R. FULLER

DURING the past two or three months, a great improvement has been noted in the higher frequencies, and by now the conditions have probably reached their peak for the summer. With hot weather coming on, we run into the usual summer static on the lower frequencies. The Australians and the Japanese are coming in very good in the early morning, and the Russians are being heard quite regularly as far east as the Mississippi, and often on the east coast.

The European situation is changing fast, and we can expect to hear from some of the liberated countries before long. Many of these countries have received aid from this country to build up their transmitters

again. At present we are limited to the Allied Headquarters stations, and of course London, Madrid and Lisbon come in occasionally on the frequencies given in the log, but are not consistent.

Tokyo is heard very well at present on 15.225 megacycles; the other frequencies are heard, some on the east coast, and most of the time on the west coast. Other Asiatics are being picked up with fair reception in the east. Among these are Singapore (under Japanese control), Chungking, and several transmitters operated by the Army on Pacific islands.

We have a number of observers scattered throughout the country, but we could

still use several more, as this is the only way we can get information on many of the stations overseas. Direct communication with these stations is practically impossible, so we must rely on reports from American observers. We would also like to contact professional listeners from overseas; especially some of our former observers in England, Scotland, France, Belgium, Norway, Sweden, Germany, Italy, India, South Africa, New Zealand and any other country from where we used to get reports. Please write to me in care of *Radio-Craft*, 25 West Broadway, New York City 7, U. S. A.

All schedules are Eastern War Time.

Freq.	Station	Location and Schedule	Freq.	Station	Location and Schedule	Freq.	Station	Location and Schedule
9.030	COBZ	HAVANA, CUBA; 8 am. to midnight.	9.615	TIPG	SAN JOSE, COSTA RICA; heard at 9 pm.	9.855	KWIX	SAN FRANCISCO, CALIFORNIA; New Guinea beam. 5 to 6:45 am.
9.082	CNR3	RABAT, FRENCH MOROCCO; 1 to 4 am.; 3 to 6:45 pm.	9.615	XERQ	MEXICO CITY, MEXICO; evenings.	9.855	WNRA	NEW YORK CITY; European beam. 3 to 8 am.; 3 to 11 pm.
9.095	CR6	ANGOLA; 3:45 to 4:30 pm.	9.625	XGCA	SOMEWHERE IN CHINA; 7 to 8:45 am.	9.897	WBOS	BOSTON, MASSACHUSETTS; European beam. 2:30 to 5:45 pm; 6 to 7 pm.
9.120	—	BALIKPAPAN, BORNEO; heard 6 to 7 pm.	9.625	GWO	LONDON, ENGLAND; Africa beam. 1 to 2:15 am.	9.897	WLWL	CINCINNATI, OHIO; North Africa beam. 7:15 to 11 pm.
9.125	HAT4	BUDAPEST, HUNGARY.	9.630	CBFX	MONTREAL, CANADA; evenings till 12:05 am.	9.897	KROJ	LOS ANGELES, CALIFORNIA; Southwest Pacific beam. 3 to 4:45 am; Alaska beam, midnight to 2:45 am; noon to 1:45 pm; Australian beam. 2 to 3:45 pm.
9.130	HI2G	CIUDAD TRUJILLO, DOMINICAN REPUBLIC; heard at 10 pm.	9.640	GVZ	LONDON, ENGLAND; North America beam. 5:15 to 11:45 pm; Pacific beam. 1:45 to 5 am.	9.915	GRU	LONDON, ENGLAND; Pacific. 8:15 to 10 am; Africa. 1:15 to 4:30 pm; Far East. 8:15 to 11:15 am; India, midnight to 1:30; 12:15 to 1:15 pm.
9.270	COCK	HAVANA, CUBA; heard at 1 am.	9.646	XGOY	CHUNGKING, CHINA; East Asia and South Seas beam. 7:35 to 9:40 am; North America beam. 9:45 to 11:40 am; European beam. 11:45 am to 12:30 pm; East Asia and South Seas beam. 12:30 to 1:45 pm.	9.930	SVM	ATENS, GREECE; heard 2 to 7 pm.
9.340	PJY9	ISLAND OF CURACAO.	9.660	GWP	LONDON, ENGLAND; Middle East, midnight to 2:30 am; 1:30 to 3 pm.	9.958	HCJB	QUITO, ECUADOR.
9.360	CBFX	MONTREAL, CANADA; 7:30 am to 11:30 pm.	9.670	WRCA	NEW YORK CITY; Brazilian beam. 8 to 11:30 pm.	10.000	WWV	WASHINGTON, D. C.; U. S. Bureau of Standards; frequency, time and musical pitch; broadcasts continuously day and night.
9.365	—	HAVANA, CUBA; heard at 6:30 pm.	9.670	WNBI	NEW YORK CITY; South America beam. 6:45 to 8:45 am; European beam. 3:45 to 5:30 pm.	10.050	SUV	CAIRO, EGYPT.
9.410	GRI	LONDON, ENGLAND.	9.675	JVW2	TOKYO, JAPAN; 3 to 6 am; 6:30 to 8:15 am; 8:30 to 10:40 am; 10:55 am to 12:40 pm; 1 to 2:40 pm; 5:30 to 7:45 pm.	10.130	HH3W	PORT-AU-PRINCE, HAITI; 1 to 5 pm; 7 to 11:30 pm.
9.440	FZI	BRAZAVILLE, FRENCH WEST AFRICA; off at 7:45 pm.	9.680	XEQQ	MEXICO CITY, MEXICO; evenings.	10.169	—	PARIS, FRANCE; Station Paree' heard in press reports to NBC and CBS in New York City.
9.465	TAP	ANKARA, TURKEY; heard at 1 and 4 pm. in French and English.	9.680	VLV6	PERTH, AUSTRALIA; 6:30 to 11:30 am; 6 to 9:45 pm.	10.220	PSH	RIO DE JANEIRO, BRAZIL; evenings.
9.465	JZHA	HONG KONG; 7 to 9:30 am.			10.338	HE04	BERN, SWITZERLAND; North America beam. 3:45 to 4:14 pm except Saturdays; South America beam. 7:30 to 9 pm.	
9.480	—	MOSCOW, U.S.S.R.; heard 8:10 to 8:50 pm.			10.350	LQA5	BUENOS AIRES, ARGENTINA; 7:15 to 7:35 pm.	
9.490	WCBX	NEW YORK CITY; Brazilian beam. 5 to 11:30 pm.			10.400	YPSA	SAN SALVADOR, EL SALVADOR; heard evenings.	
9.490	KNBC	SAN FRANCISCO, CALIFORNIA; East Indies beam, 11:30 pm. to 4:45 am.			10.620	KES3	SAN FRANCISCO, CALIFORNIA; Hawaiian beam. 7 pm to 1 am.	
9.490	GWF	LONDON, ENGLAND.			10.780	SDB2	STOCKHOLM, SWEDEN; about 11 am or noon.	
9.500	XEWV	MEXICO CITY, MEXICO; 9 am. to 3 am.			11.040	CSW6	LISBON, PORTUGAL; Brazilian beam. 6:45 to 8:45 pm.	
9.510	TAP	ANKARA, TURKEY; 1 to 2 pm.			11.090	—	PONTA DEL GADA, AZORES; heard at 2:45 pm.	
9.510	GSB	LONDON, ENGLAND; Near East, midnight to 2 am; 11:45 am to 5 pm; South America. 5:15 to 10:15 pm; Far East, midnight to 4 am; Italy, 5 to 6 am; 12:45 to 2 pm.			11.115	MCH	LUXEMBOURG; heard with Army Hour for New York.	
9.520	—	COPENHAGEN, DENMARK; heard 8 to 11 pm.			11.145	WCBN	NEW YORK CITY; European beam. 1:30 to 4:15 pm.	
9.520	—	PARIS, FRANCE; 6 to 7 pm; 10:30 to 11:15 pm.			11.405	—	DAKAR, FRENCH WEST AFRICA; 2:45 to 4:55 pm.	
9.525	GWJ	LONDON, ENGLAND.			11.616	COK	HAVANA, CUBA; noon to midnight.	
9.530	WGEO	SCHENECTADY, NEW YORK; South America beam. 6 pm to midnight.			11.645	—	BELGIAN NATIONAL RADIO; evenings about 8:30.	
9.535	JZI	TOKYO, JAPAN; heard at 2 and 11:30 pm and 3 am.			11.680	CMCY	HAVANA, CUBA; heard at 11 am.	
9.535	—	BERN, SWITZERLAND; to North America at 9:30 to 11 pm.			11.680	GRG	LONDON, ENGLAND; Near East. 1 to 4 am; Middle East. noon to 2:45 pm.	
9.538	—	"RADIO SHONAN" AT SINGAPORE; heard at 7:25 to 7:30 am.			11.690	XGRS	SHANGHAI, CHINA; 11:15 am to 12:30 pm.	
9.540	VLG2	MELBOURNE, AUSTRALIA; 8:30 to 11 am.			11.696	HP5A	PANAMA CITY, PANAMA; 8 am to midnight.	
9.540	CJCA	EDMONTON, CANADA; heard at 10:30 am; afternoons.			11.700	GVW	LONDON, ENGLAND; Africa. 11:30 am to 5 pm.	
9.540	VLC5	SHEPPARTON, AUSTRALIA; 8 to 8:45 am.			11.700	PRL8	RIO DE JANEIRO, BRAZIL.	
9.550	GWB	LONDON, ENGLAND.			11.705	SBP	STOCKHOLM, SWEDEN.	
9.550	KGEI	SAN FRANCISCO, CALIFORNIA; Oriental beam. 1:20 to 4:45 am; Hawaiian beam. noon to 1:15 pm.			11.705	—	MONTEVIDEO, URUGUAY; heard at 8 pm.	
9.555	XETT	MEXICO CITY, MEXICO.			11.705	CBFY	VERCHERES, CANADA; 11 am to noon.	
9.565	—	MOSCOW, U.S.S.R.; 6 to 6:45 pm; 7:40 to 8:30 am.			11.710	WLWS2	CINCINNATI, OHIO; South America beam. 6 to 8:15 pm; 8:30 to 10:30 pm.	
9.570	KWIX	SAN FRANCISCO, CALIFORNIA; Oriental beam. 7 to 9:45 am.			11.710	WLWK	CINCINNATI, OHIO; South America beam. 6:45 to 8:15 am; European beam. 8:30 am to 5:30 pm.	
9.570	WRUW	BOSTON, MASSACHUSETTS; European beam. 4:30 to 6 pm.			11.710	VLG3	MELBOURNE, AUSTRALIA; 1:15 to 1:45 am.	
9.570	KWID	SAN FRANCISCO, CALIFORNIA; Oriental beam. 12:15 to 4:45 am; South American beam. 7:45 pm to midnight.			11.718	CR7BH	MARQUIS, MOZAMBIQUE.	
9.580	GSC	LONDON, ENGLAND; South America beam. 5:15 to 10:15 pm.			11.720	PRL8	RIO DE JANEIRO, BRAZIL; 9:35 to 10:45 pm; off Sundays.	
9.580	VLG	MELBOURNE, AUSTRALIA; 10:15 to 10:45 am.			11.720	CKRX	WINNIPEG, CANADA.	
9.580	VLR	MELBOURNE, AUSTRALIA; 4 to 9:30 am.			11.725	JVW3	TOKYO, JAPAN; heard at 2 pm.	
9.590	WLWO	CINCINNATI, OHIO; European beam. 4 to 5:45 pm; South America beam. 7 pm to 1:15 am.			11.730	WRUL	BOSTON, MASSACHUSETTS; European beam. 6:30 to 8 am; 10:30 am to 6 pm; Mexican beam. 8:30 to 9:15 am; 7:30 pm to 2 am; Caribbean beam. 6:15 to 7:15 pm.	
9.590	VUD4	DELHI, INDIA; 9 to 11:50 pm; 2 to 5 am; 6:30 to 8 am; 8:30 am to 4:45 pm.			11.730	GVV	LONDON, ENGLAND.	
9.590	—	SAN JOSE, COSTA RICA; 7 to 7:30 pm.			11.740	COCY	HAVANA, CUBA; afternoons.	
9.595	—	ATHLONE, IRELAND; 5:10 to 5:30 pm.						
9.600	XEYU	MEXICO CITY, MEXICO; heard late afternoons and evenings.						
9.600	GRY	LONDON, ENGLAND; Africa beam. 1:15 to 5 pm; Near East. 2 to 5 pm.						
9.608	ZRL	CAPE TOWN, SOUTH AFRICA; 10 to 11:45 am.						
9.610	ZYC8	RIO DE JANEIRO, BRAZIL.						
9.610	MCH	LUXEMBOURG; heard irregularly at 5:30 pm calling New York.						
9.015	VLC6	MELBOURNE, AUSTRALIA; 8:30 to 9 am; 11 to 11:45 am.						

"WAVE TRAP"



Suggested by: Gus Britzman, Houston, Mo.

9.685	TGWA	GUATEMALA CITY, GUATEMALA; Sundays at 7:55 pm.
9.690	GRX	LONDON, ENGLAND; Australia beam. 1:45 to 6 am.
9.693	JIE2	TAIHOBU, FORMOSA.
9.700	WRUS	BOSTON, MASSACHUSETTS; Central America beam. 7:30 pm to 2 am.
9.700	WRUW	BOSTON, MASSACHUSETTS; European beam. 6:30 to 8 am.
9.700	KNBC	SAN FRANCISCO, CALIFORNIA; Oriental beam. 5 to 9 am; East Indies beam. 1 to 3:45 pm.
9.700	WLWL	CINCINNATI, OHIO; European beam. 4 to 4:45 pm; 5 to 7 pm.
9.705	—	FORT DE FRANCE, MARTINIQUE; heard at 6:30 pm.
9.720	PRL7	RIO DE JANEIRO, BRAZIL; 4:10 to 9:50 pm.
9.730	XGOA	CHUNGKING, CHINA; 1:30 to 2:40 am; 8:30 to 10 am.
9.735	CSW7	LISBON, PORTUGAL; 9 to 10 pm.
9.735	CXA15	MONTEVIDEO, URUGUAY.
9.750	WLWRI	CINCINNATI, OHIO; European beam. 7 am to 11 pm.
9.750	KCBF	LOS ANGELES, CALIFORNIA; South America beam, midnight to 2 am; Oriental beam. 5 am to 1 pm.
9.785	OTC	LEOPOLDVILLE, BELGIAN CONGO; relays BBC at 9:30 pm to 12:45 am.
9.825	GRH	LONDON, ENGLAND; North America. 5:15 pm to 12:45 am; Africa. 2:30 to 8 am; 3 to 5 pm.
9.835	—	BUDAPEST, HUNGARY. "HUNGARIAN NATIONS RADIO"; 1:15 to 1:30 pm.

(Continued on page 673)

**IT'S UP TO YOU
TO HELP MAKE
2=3 WITH...**

A job for seasoned executives—this 7th War Loan! Especially when we've got to make 2 war loans total just about as much as all 3 in 1944! Putting this over demands the combined and *continued* efforts of the "No. 1" men of American industry.

This means marshaling your plant drive to make every payday—from now 'til June 30th—do its share toward the success of the 7th. Directing the drive is not enough. It's equally important to check to see that your directions are being carried out—intelligently!

For example, has every employee had:

- 1 an opportunity to see the new Treasury film, "Mr. and Mrs. America"?
- 2 a copy of "How To Get There," the new Finance Division booklet?
- 3 a new bond-holding envelope with explanation of its convenience?
- 4 7th War Loan posters prominently displayed in his or her department?
- 5 information on the department quota—and an urgent personal solicitation to do his or her share?



If you haven't a copy of this important booklet, "7th War Loan Company Quotas," get in touch immediately with your local War Finance Chairman.

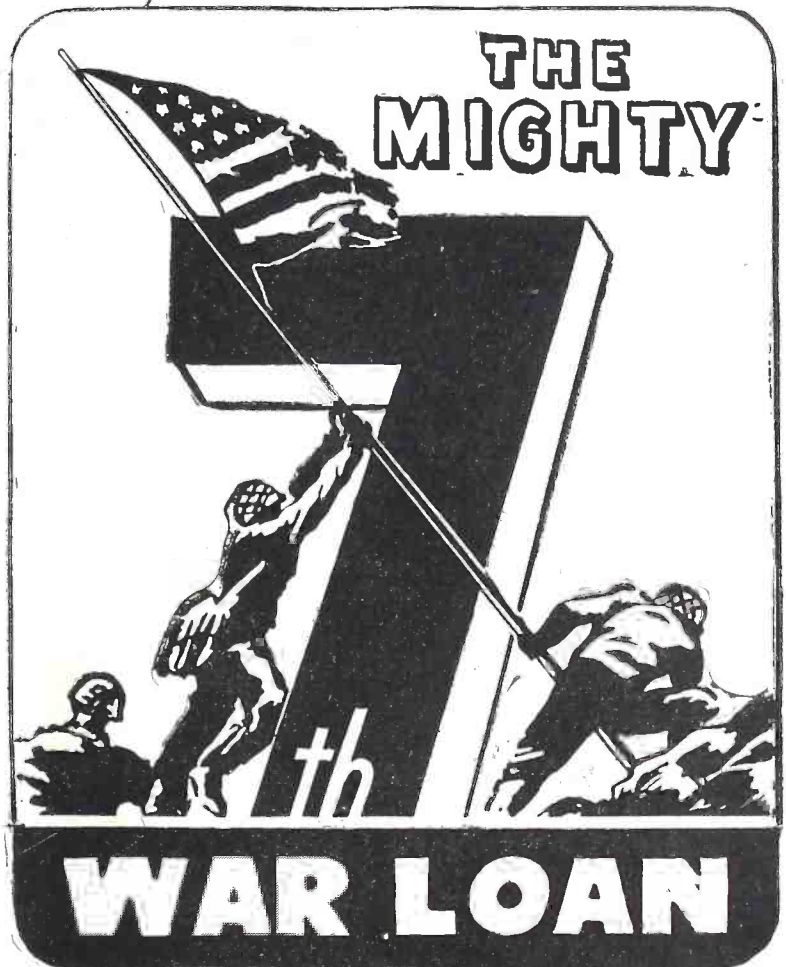

Remember, meeting—and beating—your highest-yet 7th War Loan quota is a task calling for "No. 1" executive ability. Your full cooperation is needed to make a fine showing in the 7th! Do not hesitate to ask your local War Finance Chairman for any desired aid. It will be gladly and promptly given.

The Treasury Department acknowledges with appreciation the publication of this message by

RADIO-CRAFT

★ This is an official U. S. Treasury advertisement prepared under the auspices of Treasury Department and War Advertising Council ★

New Radio-Electronic Devices

SEALED METER

Marion Electrical Inst. Co.
Manchester, N. H.

THE meter illustrated during testing processes at the Marion Research labs was placed in a Pyrex beaker of boiling brine. The meter had been boiled and frozen alternately for twelve-hour periods for a total of eight days. Maximum zero shift at any time during these tests was .75%.

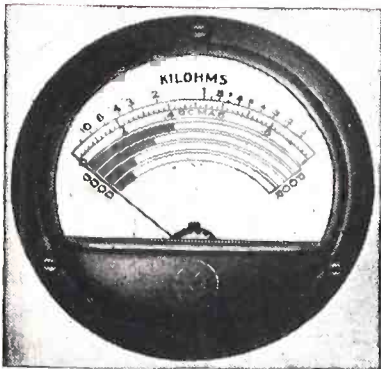

Maximum errors in current at full scale reading throughout the test was .5%. Throughout this cycling the glass-to-metal seals maintained complete hermetic sealing for the instrument and there was absolutely no moisture penetration.

The instrument was then

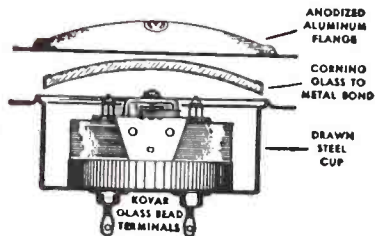

frozen with dry ice to minus 40 F., and the ice was melted away from the window with a hot soldering iron. The soldering iron barrel was rested on the center of the glass window. Neither the glass nor the seals were at all disturbed by this very severe test. The instrument continued to function properly with maximum errors no greater than those indicated for the boiling test.—Radio-Craft

GENEMOTOR

Carter Motor Co.
Chicago, Illinois

THE original Carter Genemotor, forerunner of many of the dynamotors of today,

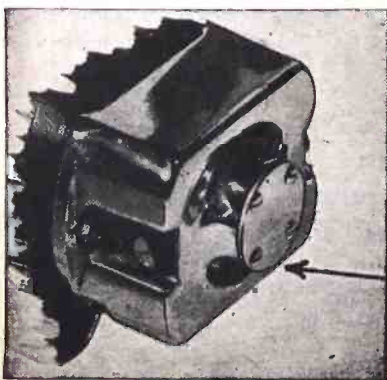

was placed on the market in about 1931 and was the first dynamotor generally available to the police and commercial trade fields.

Although the general pattern is even now being followed in production, some small changes have taken place which have somewhat improved its performance. The original bearing-bracket has been discarded, and instead an improved iron or rigidity and trueness without adding to the weight. (See cut, in which an arrow points at the new-type bearing.)

The field laminations are of a smaller gauge, lowering the running temperature and increasing the life of the unit. In order to make servicing easy in extreme conditions, inspection covers which are readily demountable, cover the ball-bearing ends, and the bearings can be greased without disassembling the entire unit.—Radio-Craft

TN CONDENSER

E. F. Johnson Co.
Waseca, Minn.

THIS new type TN condenser is an addition to the type N line manufactured for use in neutralizing circuits of radio transmitters. It features the familiar compact cylindrical construction in a high-voltage design.

Two sizes are available, rated at 45,000 volts and 35,000 volts peak breakdown, respectively. Capacity ranges are 33.1 to 12.6 mmf. for the former and 26.0 to 7.2 mmf. for the latter size.

Rough capacity adjustment is

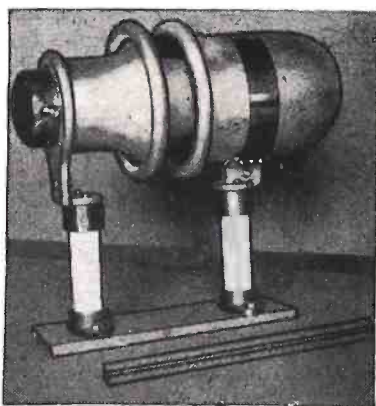

made by moving the outer cylinder under the clamp, and precision settings are made by rotation of a shaft, the location of which may be changed in steps of 45 degrees around the axis of the condenser.

The illustration includes a 12-inch scale to indicate the approximate size of the condenser. Material is spun and cast aluminum. Connections are made direct to aluminum castings and leads may come off at any angle.—Radio-Craft

VOLTAMMETER

Associated Research
Chicago, Illinois

CONTAINED in this one instrument, are an A.C. voltmeter and an A.C. ammeter. The ammeter (at right) measures from 0.2 to 500 amperes in eight current ranges: 0-1, 0-5, 0-10, 0-25, 0-50, 0-100, 0-250, 0-500.

The voltmeter (at left) meas-



ures from 30 to 600 volts in three ranges: 0-150, 0-300, 0-600. The voltmeter can also be used on D.C. at these ranges.

An inserted primary current transformer with 8-foot secondary leads facilitates the measurement of current on the 0-100, 0-250, and 0-500 ampere scales without subjecting the meter to stray magnetic fields from electrical apparatus.—Radio-Craft

AMPLIFIER UNIT

The Langevin Co.
New York, N. Y.

THE 102 Series Amplifiers with mounting accessories meet frequency modulation requirements as to frequency response, power output versus distortion, and noise level.

Type 102-A has input impedances of 30/250; output impedance 600 ohms; frequency response 30/16,000 C.P.S.

Type 102-B is a three-stage amplifier with a gain of 95 D.B. It employs input stage elec-

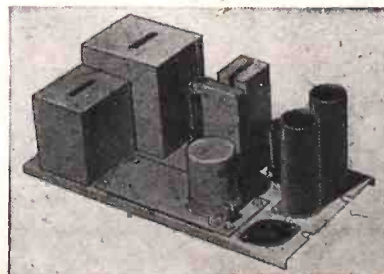

tronic mixing, and is intended for high-grade public address installations.

Type 102-C consists of a three-stage amplifier, fixed gain, adjustable, 75/85/95 D.B.

Type 102-D is a two-stage amplifier with input impedance of 600 ohms and bridging; fixed gain 600 ohms; input 61 D.B.; bridging input 45 D.B.—Radio-Craft

POWER SWITCHES

Centralab, Division of
Globe-Union, Inc.
Milwaukee, Wisc.

CENTRALAB "J" switches for power applications, going into production this month, will be available from stock, in one to five sections, with shorting or nonshorting type contacts. In addition to the complete units, sections and indexes will be available separately for individual assembly in any desired combination. The switching combinations for the present will be one pole, 17 positions (18 positions, continuous rotation, with eighteenth position "off") and 3 poles, 5 positions, (6 positions, with sixth position "off.") All units will be furnished with adjustable stops for limiting the desired number of positions.

Switches will have single hole, bushing mounting. In addition to this, there will be tie-rod extensions at both the front and rear of the switch to serve as locating keys and offer additional support in mounting. Locknuts, lockwashers and a 2¼-inch bar knob will be furnished with each unit. The bar knob has double set screws.

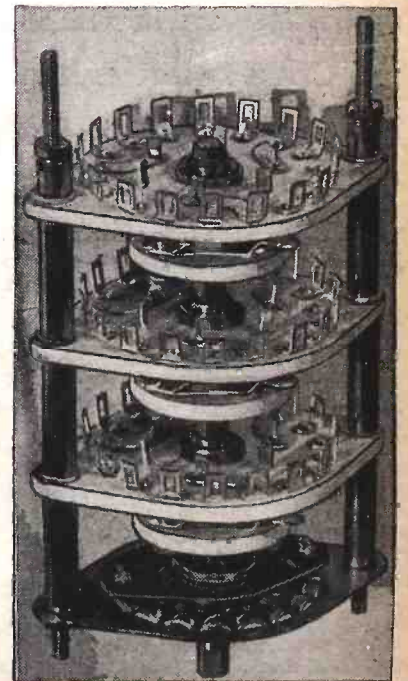

These units will have double-roller index with minimum life operation of 25,000 cycles. The contact buttons will be solid silver, and the terminals lug type. The rotor operating shaft will be square, snugly fitting a staked sleeve in the Steatite rotors to insure accuracy of positioning. The sections will be grade 15 steatite, wax impregnated. The switch will be rated at 7½ amperes at 60 cycles, 115 volts. The minimum voltage breakdown between critical points will be more than 3000 volts RMS.—Radio-Craft

RETURNED MEN AND RADIO AN OPPORTUNITY BOOKLET

OPPORTUNITIES for returning servicemen in radio and electronics are outlined by Brigadier General David Sarnoff, president of Radio Corporation of America, in a booklet just released by RCA as an aid to war veterans interested in applying their wartime training and experience to development of careers in civilian life.

"Yesterday's high-school youth," says General Sarnoff, "is today's expert radioman. Why should the druggist's clerk, who has become proficient in the technical servicing of radio and radar apparatus, return to the drug store? Practical experience gained in war, backed by a zest for study in civilian life, will provide a valuable background that will make it much easier to open doors of opportunity in business and industry."

Listed among radio and electronic fields beckoning servicemen are those of broadcasting, television, radar, radio-facsimile, radio relays, radiothermics, electron microscopy, supersonics, aircraft and marine radio. General Sarnoff suggests that the "electronizing of industry" also may prove to be an attractive occupation for returning veterans. He called attention to a recent survey which reveals a total of 16,800 electronic devices in use in 796 American industrial plants.

The booklet points out that opportunities are as numerous at the higher levels. "There is always something new to be discovered about radio and electronics.

... No radio instrument or system is ever final." This leads to a continual search for new research workers and scientists. Many the college student who has discovered an unsuspected aptitude for science will be able to return to school to further his knowledge of electronics and take his place among tomorrow's leaders of the theoretical branch of the industry.

Men who created opportunities for themselves in radio at the end of the last war reached important positions in the field. The opportunity today is immeasurably greater because of the new developments just before the war, during it, and a number—such as Citizens' Radio—which will be purely postwar developments.

The booklet—which is free of charge—runs to 28 pages and includes a bibliography of recent works on radio and electronic subjects. It can be obtained through *Radio-Craft*. Address all requests to "Opportunities," c/o *Radio-Craft*, 25 West Broadway, New York 7, N. Y.

BELOVED

By VIVIAN STRATTON

Although I have a perfect wife
YOU are the idol of my life.
To you I steal when things go wrong—
You cheer me with a plaintive song.
You never nag me when I smoke,
Nor give a darn if I am broke!
And beauty? Gosh! You're quite complete!
I'm swept completely off my feet.
Now, friends, hold on . . . don't lose your
shirt,
Nor call me "a deceitful flirt."
I merely praise, I'd have you know,
The virtues of my RADIO!

RADIO-CRAFT for JULY, 1945



*Higher
and Higher*

Electronic Winding Co. has developed special high quality coils for Ultra High Frequency work. Development of our coils has kept pace constantly with the development of high frequency communications equipment and out of our intensive war experience will come a new and finer product ready to do a new and finer job on the rapidly expanding frontiers of radio communications.

Electronic Winding Co.

5031 BROADWAY
CHICAGO 40, ILL.

★ ★ MANUFACTURERS OF EXTRA
QUALITY COILS FOR PRECISION
COMMUNICATIONS EQUIPMENT

INVENTIONS WANTED

THE War Department has released a number of specifications for inventions wanted which so far have not been solved. They are desired for our Armed Forces. There are three releases by the War Department. These can be had by addressing:
**National Inventors Council
 Department of Commerce
 Washington 25, D. C.**

We are giving below a few selected problems in the solution of which radio and electronics can conceivably be used. The numbers given refer to the original numbers in the government releases.

Some Problems in which the Army is Interested

- 4. Detectors of enemy personnel who may be approaching (unseen) on jungle trails or fences or similar barriers.
- 5. Sonic or supersonic means or methods of signalling in the field.
- 6. Improved means or methods of signalling the identification of ground troops to friendly airplanes and vice versa.
- 12. Detectors and methods for locating non-metallic land mines.
- 13. Equipment or methods for removing land mines rapidly from mine fields without injury to equipment or personnel.
- 16. Means of defeating darkness to permit vision at night without aid of visible reflected light. *Note:* Probably involves an apparatus to translate infra-red rays to visible light.
- 17. Means of long-distance communication outside the present scope of radio and not restricted by line-of-sight projection.

Some Non-Confidential Problems Group III

- 4. An accurate simple cable tension reading instrument.
- 25. Design of dependable thermostats for control of heating clothing to operate on D.C., small enough to be used in gloves and boots.
- 34. Simple and light detonation indicator for installation in airplanes.

Inventive Problems

Released by the War Department

- 10. Method of stabilizing an aerial camera or of indicating the vertical angle of the camera at the instant of exposure to within 5 minutes of arc.
- 12. Optical method for determining the difference between an artificial green and a natural green.
- 14. Location and destruction of concealed enemy emplacements, pillboxes and similar strong points.
- 15. Methods of protecting our vehicles from the effects of enemy land mines.
- 16. Improvements in tank vision devices and control instruments. There is special interest in reducing space requirements and improving performance of gyroscopic compasses.

BETTER STORAGE BATTERY

The nickel-cadmium storage battery is now much in the news because of the U. S. Government suit against two storage battery manufacturers for alleged suppression of its manufacture in the country. The battery, hitherto almost unheard-of here, is similar to the nickel-iron or Edison battery but better. Nickel-cadmium batteries are much lighter than the common lead-acid type, stand extreme cold much better, hold charge for longer periods when left idle, and have longer life. They are also practically unaffected by being left for considerable periods of time in a discharged condition, and use twice as much of their active materials as a lead battery during their discharge.

CONCORD

Amplifiers Intercoms and Recorders

FOR EVERY PURPOSE

Concord's full line of Amplifiers range up to sizes covering 200,000 square feet indoors or 75,000 square feet outdoors. A complete line of speakers, microphones, and all essential equipment is also available.

Concord Intercom Units are carried in a variety of master and sub-station units permitting up to 100 stations.

Concord Recording Equipment—professional-type for microphone recording, radio recording, reproduction of transcriptions, public address system.

Mail the coupon below for special folders and literature which picture and describe the complete Concord line of Amplifiers, Intercoms and Recorders.

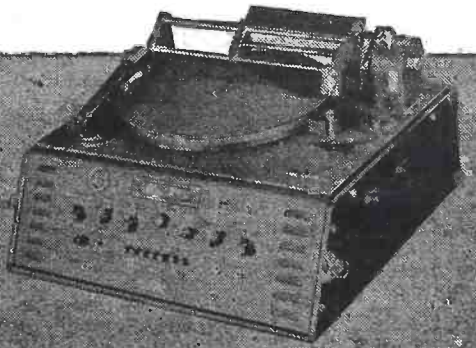
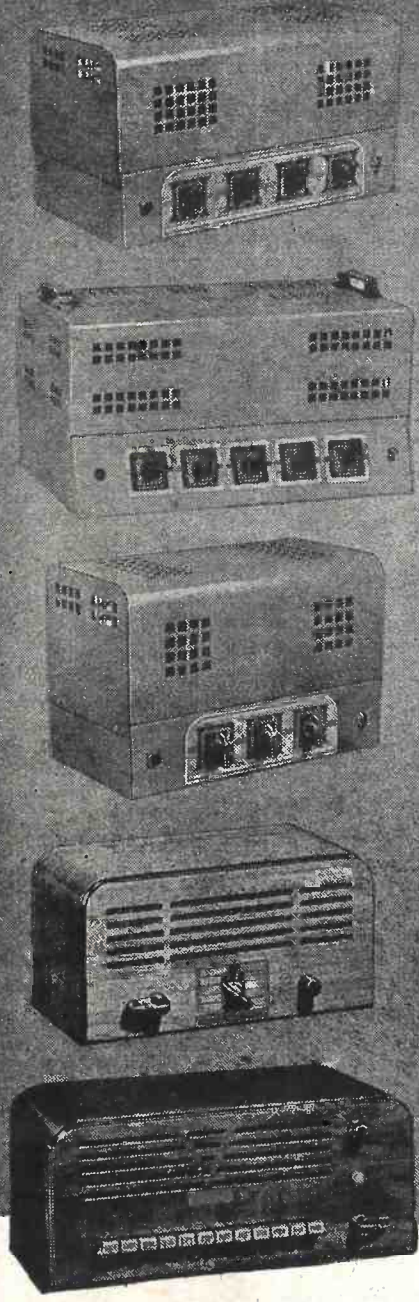

CONCORD RADIO CORPORATION
Lafayette Radio Corporation
 CHICAGO 7, ILL. ATLANTA 3, GA.
 901 W. Jackson Blvd. 265 Peachtree Street

Concord Radio Corporation
 901 W. Jackson Blvd. Dept. RC-75
 Chicago 7, Illinois

Please send me at once, literature covering your line of Amplifiers, Intercoms and Recorders.

Name.....
 Address.....
 City.....State.....

TRY THIS ONE!

TUBE TESTER

Figure 1

This tester has been in operation over a year and really does a good job. The transformer was built from a power transformer. The four test switches were made from Yaxley anti-capacity switches. The filament selector is a Yaxley non-short-throwing 17-point switch. Flexible leads and jumpers plug into jacks connected to the sockets.

For the grid test, contact is made either to 0 or 7.5 volts, the change being noted on the millimeter. Opening the cathode return indicates whether appreciable leakage is present. For testing diodes I use the 30-volt tap with 4000 ohms in series, a switch contacting either one diode plate or the other.

For protection I use a neon short-indicator.

CHARLES O. MAXIM,
Wakefield, Mass.

Radio-Craft wants original kinks from its readers, and will award a seven-month subscription for each one published. To be accepted, ideas must be new and useful. Send your pet short-cut or new idea in today!

TUBE ISOLATION

If you ever have occasion to "isolate" a tube while servicing a receiver wired in series, so as to keep the other tubes in operation, here is a real help.

I use an old base from a discarded tube as an adapter and connect filament leads only to an external socket. The tube in question is plugged into the socket.

This is far superior to using resistors or bulbs which do not always maintain the original filament current in the remaining tubes.

K. BRADLEY,
Toronto, Ont.

AUDIO "SQUEGGER"

Figure 2

I have been using this audio oscillator circuit for some time. It is simple to construct, very cheap to build and uses no large or hard-to-get parts such as transformers.

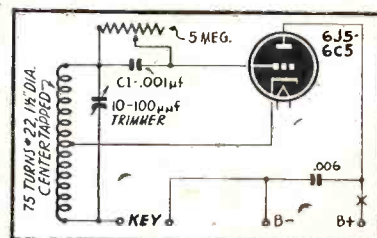

Figure 2

Actually it is nothing but a simple self-pulsing oscillator with the pulse rate falling in the desired part of the audio spectrum. The one I have at present is adjusted to oscillate at 800 cycles which is a standard MCW (modulated continuous wave) frequency. If the coil specifications are followed, it will transmit a modulated CW signal which can be picked up on any broadcast set within 20 or 30 feet. No connections between the broadcast set and the oscillator are necessary.

If the plate lead is broken at point X one or more pairs of headphones may be operated directly from the oscillator without the use of the broadcast set.

If R-1 is set too low, which would increase the audio frequency, the oscillator may start acting as a super-regenerative detector and cause hissing in the broadcast set. This will occur only when the frequency is set much too high for proper audio output (around 6 Kc.). It can be eliminated by experimenting with the value of C-1. Using this exact circuit, no such trouble should be encountered.

J. W. HARFORD, RT 1/c,
San Francisco, Calif.

PEDAL CONTROL

Electronic musical instrument experimenters desiring a pedal type volume control can find all the parts necessary at the nearest sewing machine repair shop.

Strip off the burned-out resistance element from a defective sewing machine rheostat, clean the contact points with fine sandpaper and polish with a piece of canvas or felt. Finally coat contacts and wiper arm with mineral oil.

The total required resistance is soldered between the contacts

to make up the rheostat. For a linear taper, use equal resistors.

E. E. YOUNGKIN,
Altoona, Penn.

METER BOX

Figure 3

A very attractive and neat plastic meter case can be molded from old phonograph records. One must choose a large 12-inch record preferably with cutting only on one side. This makes a much smoother face finish, although a two-sided disc will serve nicely.

The four sides are laid out upon the record with meter hole in center and marked with an awl or pencil. The latter must be held into the light while cutting will reflect upon the dark surface.

Placing the record over a hot flame, as of gas, will make it flimsy and soft. (Try boiling water.—Editor.) The sides can then be cut with a straight-edge and razor blade.

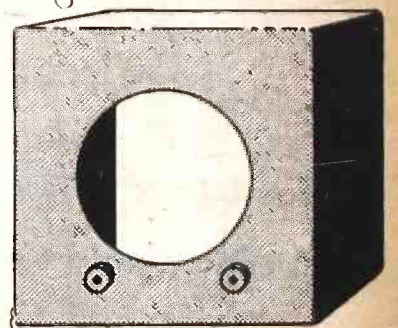

The record will become hard and brittle as it cools off and must be watched closely while bending. A straight-edge will help to make square, sharp edges.

After the four sides are folded

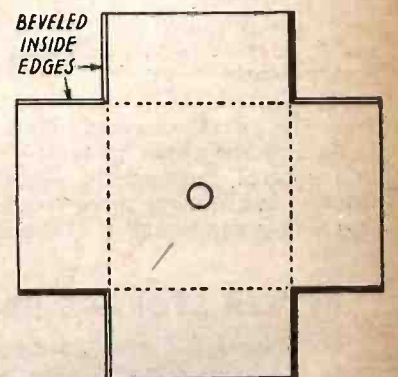

Figure 3

up tight, small pieces of record are placed inside the corners and heated with a hot, round object such as a rat-tail file to mold and bevel the corners. The outside corners may be beveled off with a fine file after joints have been made and cooled.

The case can be finished with a glossy coat of varnish.

H. C. DAVIDSON,
Robinsfield, Ga.

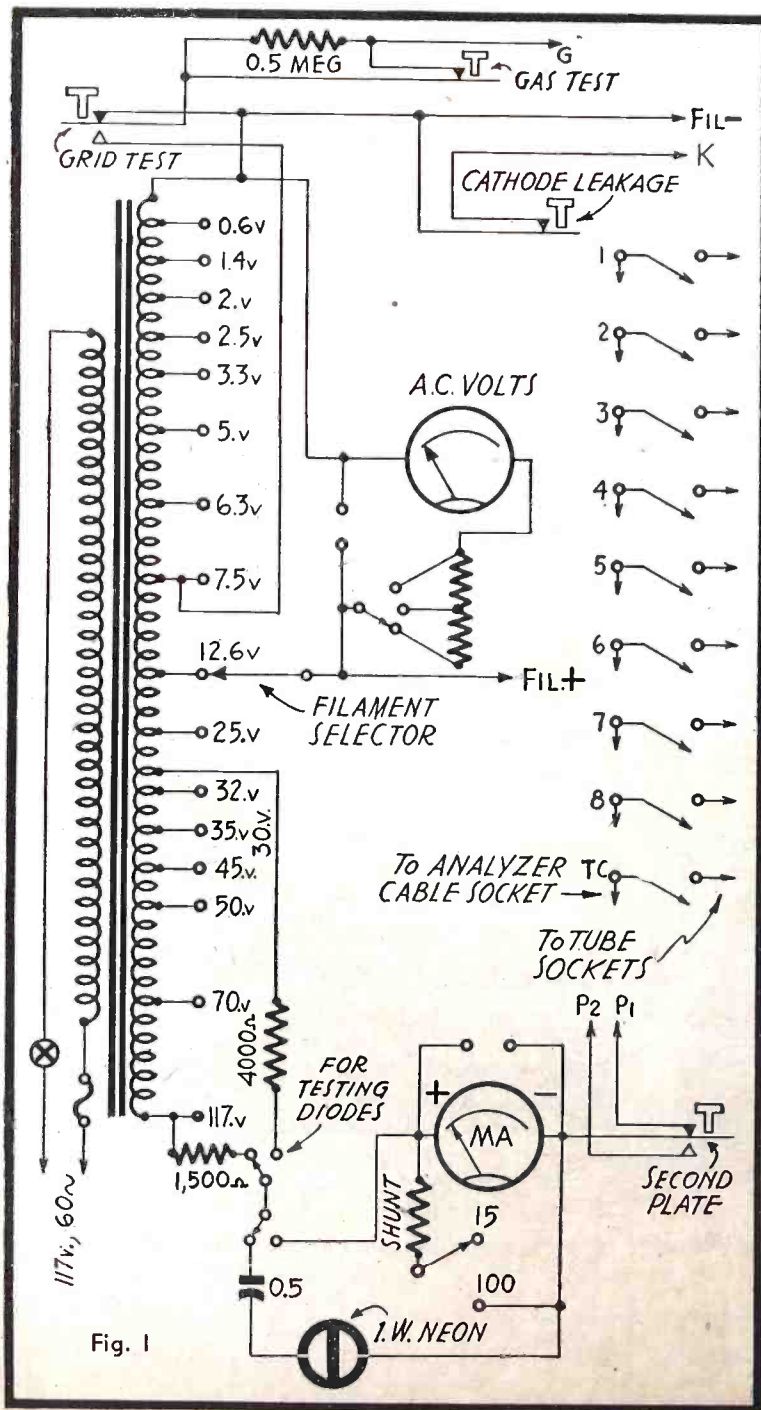

Fig. 1

10,000 PARTS

Ten thousand different
radio and electronic parts immediately
available on priorities

SERVICE

Trained expeditors select
and ship same day your order
is received

EXPERIENCE

Known since 1922 as reliable
jobbers, wholesalers and manufacturers of
radio and electronic equipment

Radio Wire Television Inc.

100 Sixth Ave. (Dept. A-7) New York 13, N. Y.
Boston, Mass. Newark, N. J.
World's largest Radio Supply House

Originators and
Peacetime Marketers,
of the celebrated

Lafayette Radio

Write today for our bargain
flyers and special bulletins.

OSCILLOSCOPES FOR TRAINEES

(Continued from page 633)

to create the electron stream in the CRT. This is done by tapping voltages from the divider, and applying them to the cathode, grid, and anodes of the tube. Note that the positive is ground and the "hot" lead is the negative one in this case.

The Sweep Circuit is an important fundamental circuit in the oscilloscope. Its purpose is to generate a changing voltage that is applied to one set of the deflection plates. Usually this sweep voltage will be applied to the horizontal deflection plates, but many scopes provide for applying it to the vertical plates if need be.

The sweep voltage is in sawtooth form; rising linearly from zero to some value, and then quickly dropping back to zero again. When applied to the plates, it causes the electron stream to move at an adjustable speed across the scope, and then when the voltage drops abruptly to zero, the stream or spot moves back to the starting spot at a much faster rate, drawing a bright line across the screen on the forward motion only.

The sweep circuit will usually be composed of an 884, 885, or other thyratron tube in a relaxation oscillator circuit. In the grid circuit will be found the adjustment resistor (Sync Control) for synchronizing the sweep voltage with that from an external source. In the plate circuit there will be an adjustable capacity and an adjustable resistor. The purpose of these is to adjust the frequency of the sweep voltage. The condenser switch is referred to as "Sweep Frequency Range" or "Rough Control," the resistor as "Fine Frequency Control" or "Vernier."

Amplifier Circuits are needed in an oscilloscope to provide numerous adjustments that must be made, both on signals being measured by the scope, and on signals generated inside the scope. Naturally, the signals we feed into the scope will have different amplitudes, so before we place them on the deflection plates it will be necessary to make them have the correct amplitude. To do this amplifier tubes are inserted between the signal input jack on the scope and the deflection plate or plates which impress the signal on the electron stream. So, we feed the external signal to the grid of an amplifier tube (such as the 6J7's of Fig. 2, for example) and feed the amplified signal to the deflection plate or plates.

We also need amplitude controls for the sweep voltage generated internally by the scope. We will usually find the same type of amplifier connected to the sweep generator circuit. In some scopes the amplifier circuits may be provided with switching arrangements for giving amplification to various signals, and in such cases the horizontal—sometimes also the vertical—amplifier may be used to amplify the sweep.

The amplitude adjustments will usually be potentiometers which vary the bias or the screen voltages on the amplifier tubes, or the amount of signal fed to their grids.

A systematic study of the fundamental circuits mentioned above will enable you to have a valuable understanding of your scope.

OSCILLOSCOPE CONTROLS

Our first glimpse of the front panel on an oscilloscope is usually a frightening experience, but learning the controls is not such a difficult task as it seems at first sight.

In Fig. 3 we see a panel representation

of a set of controls normally found on an oscilloscope. These controls—as may be seen from Fig. 2—are mostly potentiometers, used to vary the voltages applied to the fundamental circuits mentioned above, and are:

1. *On-Off Switch.* (Sw.) A simple switch in the primary of the transformer.

2. *Pilot Light.* This bulb shows whether or not the power is on, and indicates when the scope is ready for operation.

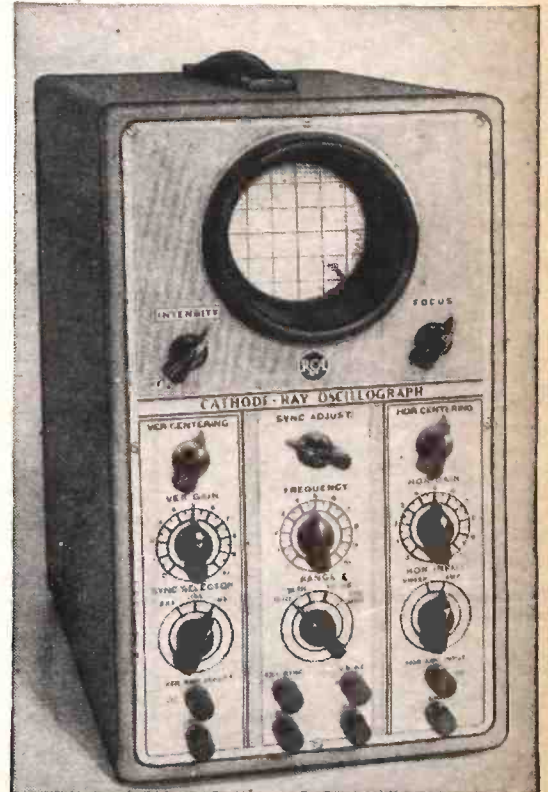

The three-inch instruments are widely used.

3. *Intensity Control.* (R_1) This control is used to make the picture on the screen more or less bright. This is done by varying the amount of bias on the control grid of the CRT. Making the grid less negative will allow more electrons to flow from the cathode into the moving electron stream. Thus the picture is brighter because more electrons are striking the screen.

4. *Focus Control.* The focus control makes the spot more or less concentrated



Fig. 3—Controls of a typical oscilloscope.

on the screen. This operates by varying the voltage on the *focusing anode* of the CRT. The action involved makes the electron stream expand or be compressed into a small point or thin moving line on the screen.

5. *Horizontal Position.* This potentiometer puts voltage on a horizontal deflection plate. Varying its intensity causes the stream to be deflected toward, or away from that plate. We use this control in centering the spot. Turning the control moves the spot *right or left*.

6. *Vertical Position.* The vertical positioning potentiometer works in the same manner as the Horizontal Position control, only it moves the spot *up or down* on the screen. These positioning controls were not used in the small instrument of Fig. 2.

7. *Sweep Frequency Range.* With this control we vary the frequency of our sawtooth variation. This is the step-by-step variable capacitance in the plate circuit of the Thyatron or 885 tube. It changes the frequency of the sawtooth sweep in wide jumps, or *across bands of frequency*.

8. *Sweep Frequency Vernier (Fine Frequency Control).* This control changes the *resistance* in the plate circuit of the thyatron. By using this we vary the frequency in *small amounts*.

9. *Horizontal Gain (Horizontal Amplitude Control).* When we use this control we are varying the amplitude of the signal being fed onto the horizontal plates. This signal is usually the sweep, so we make it move in a wider line by controlling the amplification in the sweep amplifier circuit.

10. *Vertical Gain.* This is similar to the Horizontal Amplitude Control, only it varies the degree of amplification of the input signal applied to the vertical deflection plates. This control can make a weak signal have a high amplitude, without affecting its frequency.

11. *Vertical Input (V).* This is simply a pair of jacks on which we put a signal we want to feed into the vertical deflection channel. As we said in the fundamental amplifier circuit, it goes first to the grid of the amplifier tube.

12. *Horizontal Input.* This performs the same function as the vertical input. It is used when we put an external signal on the horizontal deflection plate, instead of using the horizontal channel for the sawtooth sweep, as we usually do.

13. *Synchronizing Control.* This is another potentiometer in the grid of the Thyatron or 885 tube. The amount of voltage here controls the firing point of the sweep oscillator. When we apply a voltage of our signal variation here it causes our *sweep voltage* to synchronize with the *signal input*. This gives a steady picture on the screen.

On some scopes this is called the Locking Control. What it actually does is "lock" the sweep frequency in with the external signal being applied to the scope.

SERVICING THE SCOPE

The Oscilloscope is a sturdy instrument, and should not cause much trouble. It will take abrupt voltage changes that would ruin an instrument of a different type.

The CRT will stand a wide range of voltages applied to the deflection plates, but care must be taken to keep high potential off the control grid, or excessive cathode emission will ruin the tube. Care must also be taken to keep the spot intensity down when it is at a single point on the screen. If a brilliant spot is left on too long it will eat away the fluorescent material.

Troubleshooting on the scope is done in the normal manner, with the usual instruments. A knowledge of the circuits and the indications on the screen will enable the

PORTABLE POWER PROBLEMS

THIS MONTH—PATHE NEWS RECORDING AMPLIFIER



PORTABLE SOUND EQUIPMENT used by Pathe News' Washington staff must be ready for instant action, rain or shine. To meet all requirements of newsreel work, Pathe News engineers developed a lightweight sound amplifier—powered by a special, flat type 180-volt Burgess Battery—with sufficient output in milli-watts to operate the mirror galvanometer. Burgess engineers worked closely with Pathe sound experts to develop this battery (photo lower right).

UNUSUAL ELECTRONIC APPLICATIONS for battery power are the specialty of Burgess engineers. Ask for their help on your dry battery problem. In addition to developing batteries for specific needs, Burgess engineers have made a line of Industrial Batteries so complete that one of the standard types may be ideal for your special requirement. For further information on Industrial Batteries, see your Burgess distributor.

Burgess Battery Company, Freeport, Illinois

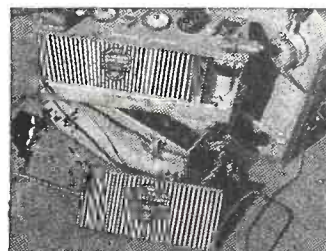
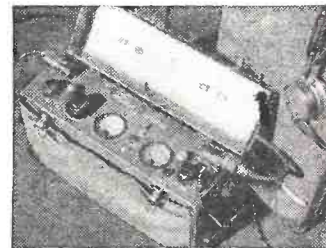

SAVE MORE PAPER—SEND IT TO WAR!



BURGESS BATTERIES

experienced serviceman to locate the circuit causing the trouble. Trouble is pinned down to one of the fundamental circuits by interpreting the screen indications. Then the circuit is checked for faulty condensers, resistors, or tubes.

When servicing the scope, the technician should remember the *high voltage* present in the CRT circuit.

Railroad radios using two frequencies are now being produced according to a release by Bendix Radio. Two-frequency communication—with quick change-over by pushbutton—makes speedy contact possible between two separate control areas in busy passenger terminals, and cuts down the time previously spent in routing messages from trains through one control area to the other.

TRAIN FOR RADIO - 12 WEEKS SHOP TRAINING I WILL FINANCE YOUR TRAINING

Trained Radio-Electronics men needed today, and they will be needed after the war. Prepare for the great opportunities now in Radio-Electronics and Television. "Learn by Doing." Free employment service for life after graduation. You can "Earn while learning". I'll finance your training if you are short of money. Mail coupon today for all details and big free book. We have facilities for men with physical disabilities. If you have a physical disability of any kind check coupon below for details.

H. C. Lewis, Pres., Radio-Electronics Div., Coyne Electrical School, Dept. 85-8H, 500 S. Paulina St., Chicago 12, Ill.

Send free book and full details. Send physical disability plan.

NAME _____
 ADDRESS _____
 CITY _____ STATE _____

SUPREME

TESTING INSTRUMENTS

"WORTH WAITING FOR"

● Though Supreme's total current production is still needed by and being sent to our Armed Forces, we are planning extensively in our engineering and production departments to bring you your post-war Supreme Testing Equipment at the earliest possible date. Instruments incorporating radical departures and improvements . . . the result of the experience and know-how gained through over sixteen years of producing instruments proved "Supreme by Comparison."

● These dependably accurate Supreme Testing Instruments will be worth waiting for.

WATCH

NEXT MONTH

for announcement of Supreme's new Model 565 Vacuum Tube Voltmeter.

SUPREME INSTRUMENTS CORP.
Greenwood, Miss., U. S. A.

Progress In Invention

Conducted by I. QUEEN

REMOTE CONTROL

William A. Tolson, Princeton, N. J.
Patent No. 2,371,415

PULSES are used to control the position of a moveable object at a distance, timing rather than amplitude being used in order to eliminate interference. The received pulses are amplified in push-pull (Fig. 1) after phase inversion. Amplification is sufficient to cause plate cut-off on the negative halves, the bias on T2 and T3 being set at substantially the input peaks. The positive pulse loops are amplified by T3 and the negative loops by T2.

When the input signal (Fig. 3) consists of positive pulses shorter than the negative pulses T4 is conductive longer than T5, and vice versa, unbalancing the circuit.

Each output tube therefore operates alternately, the current being smoothed by condensers and applied to two differentially-wound armatures. For example, when average plate current from T4 is greater than from T5, one winding is excited more than the other and the motor rotates in the corresponding direction. The motor is stationary when the currents are equal.

The motor carries control which increases one screen's voltage while decreasing that of the other. The connections are such that the plate current unbalance is decreased. The motor stops when full balance is restored.

The transmitter (2) consists of a revolving insulated drum carrying a triangular sheet of conducting material. When the moveable control is normal as shown, positive and negative pulses (due to condenser charge and discharge) are equal. Conditions are shown under "normal control" (3). Moving the control to one side or the other gives either "plus" or "minus" control, the motor rotating in the corresponding direction. The gear box G determines how long the motor runs before balance is obtained.

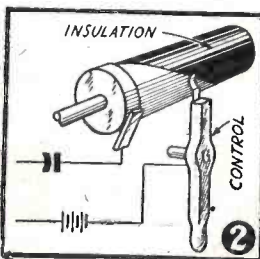
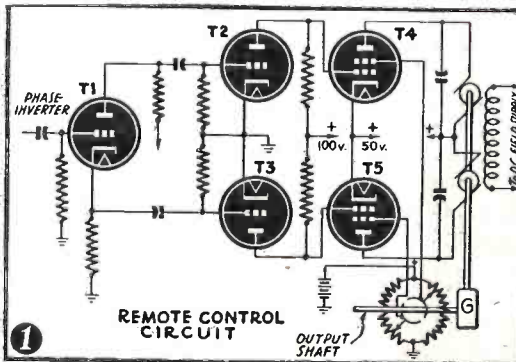
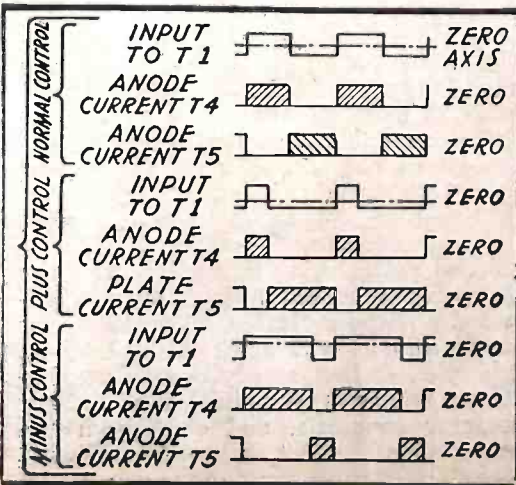

Fig. 1—The unbalancing amplifier. Fig. 2—Transmitter device. Fig. 3—Patterns for plus and minus control.



FREQUENCY MODULATION

Frederick E. Terman, Stanford University, Calif.
Patent No. 2,372,231

THIS is an improved FM transmitter which permits greater frequency swings at higher voltage levels with simple apparatus. A permanent magnet assembly and balanced armature is sealed into an evacuated bulb, the armature being free to vibrate in accordance with the

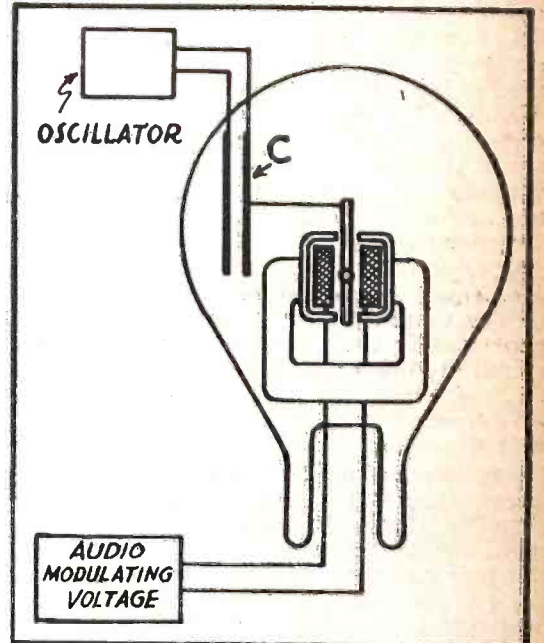

applied modulating voltage. One plate of a condenser is linked to the armature so that a change of capacitance results. Since the condenser is shunted across the R.F. oscillator tank, the carrier becomes frequency modulated.

Operation within the vacuum permits very high voltages to be modulated without breakdown. If the condenser forms all or most of the tank capacitance large swings are possible.

CONDENSER TESTER

Oliver James Morelock, Short Hills, N. J.
Patent No. 2,373,079

CONDENSERS are one of the most difficult components to test, since removal from the set is usually required. This circuit permits testing a condenser for efficiency while it remains in the radio.

A conventional oscillator is coupled to an external circuit provided with test prods. An additional degenerative circuit composed of C1, C2 and R is adjusted so that negative feedback just prevents oscillation. Under this condition the meter reads zero or very slightly since no grid current flows. When the test prods are connected across a good condenser, effectively shorting the secondary, phase relationships are disturbed and oscillation permitted. The meter now reads up-scale.

The indicating meter can preferably be a D'Arsonval microammeter with a "Good-Bad" scale. Coupling between the two windings of the oscillator coil is adjusted so that good condensers of .001 MFD or higher read "Good." A third lead with condenser C3 (.00025 MFD) in series with the secondary provides for testing condensers from .001 down to .0002 MFD. The upper scale of the meter is read when the leads are connected across 2 and 3, the lower scale when across 1 and 3.

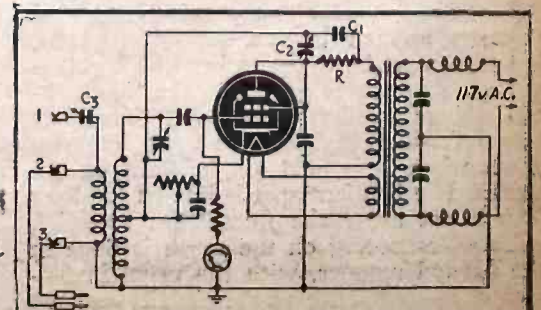

MILLIONS OF RADIO JOBS

THIRTY MILLION repair jobs are done annually by the 24,700 radio service establishments in the United States, according to a survey just completed by Frank Mansfield, director of sales research for Sylvania. Figures compiled in the survey show that more than 60,000 radiomen were employed in establishments which devoted their main attention to repairing broadcast receivers.

Among the interesting facts unearthed by the survey was one that may console the Serviceman for the abuse all-too-often heaped on him. Of all set owners queried, 92.5% believed that their repairman had done a "good job" the last time the receiver had been overhauled, and 89.3% thought charges were "fair." The average set owner—once he has time to think things over—is a reasonable individual! The percentage of capable and honest servicemen must also be high, to create such an impression among their customers.

The radioman is sorely tried by lack of necessary repair parts. More than 90% of the repairmen are making repairs by changing circuits, usually on account of inability to obtain certain tubes. Yet the tube shortage has brought little simplification to his stock. 54% of the repairmen queried carried in stock more than 250 types, 38% more than 300, and 20% stocked over 400 types of tubes. Only a little more than 6% of the radiomen feel such a multiplicity of tube types to be reasonable, and 65% feel that less than 100 types would be sufficient for the needs of any reasonable line of broadcast receivers. Of the 30,000,000 radio tubes marketed annually, 20,000,000 are sold by repairmen as part of the service on customers' receivers.

The tube is a dominant factor in radio repair. Their aging and breakdown constitute the greatest single cause of radio failure. More than 50% of the repair jobs require tubes. There is little doubt that even more tubes would be sold in connection with set servicing if the supply were greater, as many tubes slightly "low" are left in the set because replacements are unobtainable. Incidentally, three out of four servicemen preferred glass to metal tubes.

Next to tubes, the most common causes of radio breakdown are condenser failures, power supply troubles, difficulties in the tuning system, I.F. coils, R.F. coils and filters, in that order. Filters, in this case, appear to mean filter chokes, as the electrolytic condensers are obviously included under condenser failures.

The prospects after the war, according to Frank Mansfield's figures, are excellent. A minimum of 75,000 home radios and 25,000 auto radios will be in use, and the more complex circuits of FM and television sets will mean higher compensation per job. Increasing complexity may also mean more servicing, if increase in the ruggedness of parts and more attention to designing sets to stand up under use and aging does not parallel the manufacture of these more intricate pieces of equipment. To handle repair work after the war approximately 30,000 shops, with 90,000 employees, will handle approximately 50,000,000 repair jobs per year.

This by no means completes the picture, for the postwar shop will require better instruments, which in turn will create employment in test equipment factories. Special antenna installation work will be needed for all FM and television receivers. The serviceman himself will require more training than he has at present, if he is to handle postwar sound and television sets satisfactorily, according to the majority of the servicemen interviewed.

SILVER

Presents
"VOMAX"



1. Brand new post-war design . . . positively not a "warmed-over" pre-war model.
2. More than an "electronic" voltmeter, VOMAX is a true vacuum tube voltmeter in every voltage/resistance/db. function.
3. 3 through 1200 volts d.c. full scale in 6 ranges at 50, and in 6 added ranges to 3000 volts at 125, megohms input resistance.
4. 3 through 1200 volts a.c. full scale in 6 ranges at honest effective circuit loading of 6.6 megohms and 8 mmfd.
5. 0.2 through 2000 megohms in six easily read ranges.
6. -10 through +50 db. (0 db. = 1 mw. in 600 ohms) in 3 ranges.
7. 1.2 ma. through 12 amperes full scale in 6 d.c. ranges.
8. Complete signal tracing from 20 cycles through over 100 megacycles by withdrawable r.f. diode probe.
9. Absolutely stable—one zero adjustment sets all ranges. No probe shorting to set a meaningless zero which shifts as soon as probes are separated. Grid current errors completely eliminated.
10. Honest, factual accuracy: $\pm 3\%$ on d.c.; $\pm 5\%$ on a.c.; 20 μ through 100 megacycles; $\pm 2\%$ of full scale, $\pm 1\%$ of indicated resistance value.
11. Only five color-differentiated scales on $4\frac{5}{8}$ " D'Arsonval meter for a total of 38 ranges eliminate confusion.
12. Meter 100% protected against overload burnout on volts/ohms/db.

Providing amazing advances in radio receiver servicing, VOMAX is new and fresh as today. It's not an "improved" pre-war model. VOMAX is a brand new instrument born of six years' direction of classified (secret, confidential, restricted) design and production projects for Air Corps, Army, Navy, O.S.R.D. . . . special equipments designed and produced for F.C.C., C.A.A. and other government agencies. Into it has gone the distilled genius which won Grand Prix at 1937 Paris International Exposition for McMurdo Silver for the world's best radio receiver.

That sums up VOMAX in a nutshell. It's the most complete answer to radio servicing and design ever offered . . . conceived and built by a world-famous receiver engineer specifically for receiver servicing. It starts where all competitive instruments leave off.

Deliveries begin in August upon AA-5 or higher priority. Better place your order with your jobber today to insure early delivery . . . be first to get radio's newest, most complete "service station" all in one small, easily carried instrument. By itself VOMAX is the key to service profits for you.

Possessed by no other instrument, these are features only Silver can give you — revolutionary features for others to copy.

NET PRICE **\$59.85**

McMurdo Silver Company
1240 Main Street,
Hartford 3, Connecticut

Please RUSH free copy of your catalog.

NAME _____
ADDRESS _____
CITY _____ STATE _____

OVER 34 YEARS OF RADIO ENGINEERING ACHIEVEMENT

McMurdo Silver Company

1240 MAIN STREET, HARTFORD 3, CONNECTICUT

RADIO FILTER CIRCUITS

(Continued from page 642)

path through C_1 rather than the high-impedance path through R . Thus, the A.C. is effectively kept out of the load, R being rather high in value compared with the reactance of C .

The filter circuits discussed have been fundamental types, which any practicing radio serviceman is apt to encounter in his everyday work. In telephone engineering the circuits may be a good deal more complicated and the design theory is intricate.

The average serviceman will never encounter such systems, but the broadcast radio technician may find that line equalization is important to him.

In this discussion we have been concerned

with the radio serviceman's viewpoint, not that of the engineer who knows all about it, or the radio technician in broadcasting. The number of broadcasting stations in the country is limited, while there are many thousands and thousands of radio servicemen. In view of this, it seems strange that so much of technical literature should be concerned with radio broadcasting which is of limited interest, while not so much attention is given to the problems of the serviceman and to police, aviation and marine radio.

(A second and more advanced article on filter design will appear in an early issue of *Radio-Craft*).

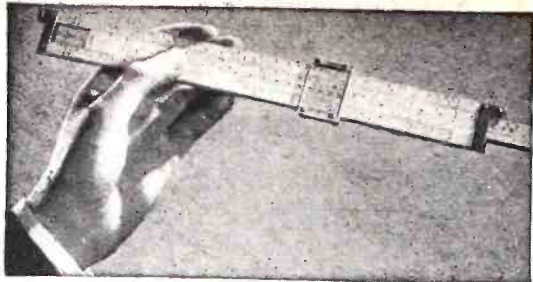

No. 1 Rule:

for a

Better Job and Secure Career in Radio-Electronics

*Add CREI Technical Training to
Your Present Experience—Then Get
That Better Radio Job You Want—
Enjoy Security!*

Thousands of new men have joined the ranks of the radio industry during the war. Now, and after final peace, even more thousands will return from the armed forces. Competition for the better technical jobs will return. Where will you fit into this picture?

If you are wise, you will look ahead and prepare for the good-paying jobs in radio-electronics and industrial electronics. Every man in radio today has the opportunity to see the amazing developments that are taking place, as well as the unlimited opportunities available to men with modern technical training.

It is up to you to decide if you will be a "screwdriver" mechanic or a real technician in a responsible engineering position.

CREI can help you prepare by providing you with a proved program of home study training that will increase your technical ability and equip you to advance to the better-paying radio jobs that offer security and opportunity. CREI home study courses provide you with up-to-date technical training, covering such important basic principles of modern, practical radio-electronics engineering as: U.H.F. circuits, cavity resonators, wave guides, Klystrons, Magnetrons and other tubes? U.H.F. as well as all other basic principles of modern, practical radio-electronics engineering are covered in CREI home study courses.

The facts about CREI and what it can do for you are printed in a 36-page booklet. It is well worth your reading. Send for it today.

● WRITE FOR NEW, FREE 36-PAGE BOOKLET

If you have had professional or amateur radio experience and want to make more money—let us help you qualify for a better radio job. **TELL US ABOUT YOURSELF**, so we can intelligently plan a course best suited for your needs.—**PLEASE STATE BRIEFLY YOUR BACKGROUND OF EXPERIENCE, EDUCATION AND PRESENT POSITION.**



CAPITOL RADIO ENGINEERING INSTITUTE

*Home Study Courses in Practical Radio-
Electronics Engineering for Profes-
sional Self-Improvement*

**Dept. RC-7, 3224 — 16th St., N. W.
WASHINGTON 10, D. C.**

Contractors to U.S. Navy—U.S. Coast Guard
—Canadian Broadcasting Corp.—Producers of
Well-trained Technical Radiomen for Industry

TUBE REPLACEMENTS

(Continued from page 625)

TABLE I

ORIGINAL TUBE	REPLACE DIRECTLY	DIFFERENT CUT-OFF	ORIGINAL TUBE	REPLACE DIRECTLY	DIFFERENT CUT-OFF
1A4P		1B4	6SH7GT	6SE7GT	
1A5GT/G	1T5GT		"	6SG7	
1B4		1A4P	6S7G		6W7G
1D5G-P		1E5G-P	6SJ7GT/G		6SK7GT/G
1E4G	1G4GT/G		6SK7GT/G		6SJ7GT/G
1E5G-P		1D5G-P	6U5	6E5	
1G4GT/G	1E4G		6U7G	6K7GT	6J7GT
1G5G	1J5G		6W6GT	6Y6G	
1J5G	1G5G		6W7G		6S7G
1LA4	1LB4		7B5	7C5	
1LA6	1LC6		7B7		7C7
1LB4	1LA4		7B8	7S7	
1LC6	1LA6		"	7J7	
1T5GT	1A5GT		7C5	7B5	
2A3	45		7C7		7B7
5T4	5U4G		7H7		7L7
5U4G	5T4		"		7T7
5V4G	5Y3GT		7J7	7B8	
"	5Z4GT/G		"	7S7	
"	5W4GT/G		7L7	7TL	
5W4GT/G	5Y3GT		7S7	7J7	
"	5V4G		"	7B8	
"	5Z4GT		7T7	7L7	
5Y3GT	5W4GT/G		12J7GT		12K7GT
"	5V4G		12K7GT		12J7GT
"	5Z4GT		12SJ7GT/G		12SK7GT/G
5Z3	83V		12K7GT/G		12SJ7GT/G
5Z4GT	5V4G		14A7		14C7
"	5W4GT		14B8	14J7	
"	5Y3GT		"	14S7	
6AB6G	6N6G		14C7		14A7
6AF5G	6P5GT		14J7	14B8	
6B6G	6Q7G		"	14S7	
6C5GT/G	6J5GT/G		14S7	14B8	
6C6	77	6D6	"	14J7	
6D6	78	6C6	24A		35
6E5	6U5		32		34
6J5GT/G	6C5GT/G		34		32
6J7GT		6K7GT	35		24A
"		6U7G	36		39
6K7GT	6U7G	6J7GT	37	76	
6N6G	6AB6G		39		36
6P5GT	6AF5G		45	2A3	
6S7G		6W7G	50Z7G	50Y6GT/G	
6SD7GT	6SE7GT		50Y6GT/G	50Z7G	
"	6SG7		57		58
"	6SH7GT		58		57
6SE7GT	6SD7GT		76	37	
"	6SG7		77	6C6	78
"	6SH7GT		78	6D6	77
6SG7	6SH7GT		83V	5Z3	
"	6SD7GT				
"	6SE7GT				
6SH7GT	6SD7GT				

1	2	3	4
5	6	7	8
9	10	11	12
13	14	15	16

ELECTRONIC Puzzle Square

By

LT. C. K. JOHNSON

Work this like a cross-word puzzle. The answer to problem No. 1 goes in square No. 1, etc. When completed, rows, columns and diagonals, etc., will total the number which is the base of common logarithms. Therefore the sum of the answers to problems 1, 2 and 3 subtracted from the total gives the answer to problem 4.

(All problems correct to one decimal place.)

- $\log_{10} N = \text{---}$ $\log_{10} N$
- What is R if $I = 10$ Amp. and $P = 320W$?
- Red is --- in the color code.
- $E^x = \text{---}$ when $x = .92$
- An inductance of .004 henrys is used with a condenser of what value in mfd. to obtain a resonant frequency of 1500 cps.?

- Tan. $59.6^\circ = \text{---}$

7. If we had a circuit as in Fig. 1 where each resistor was 10 ohms, and we wanted to convert it to a circuit as at Fig. 2 so that the resistance measured between A and B or measured between C and D, would be the same for each circuit, what resistors would we use in Fig. 2?

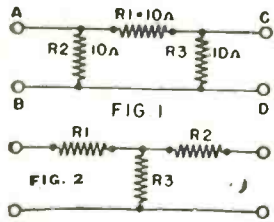

- What reading in milliamperes will be indicated by the meter?

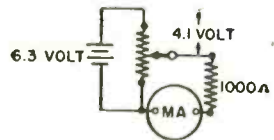

- The ratio of the circumference of a circle to its diameter is ---

- What is the total resistance between A and B?

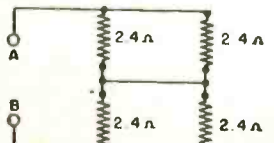

- If $\log_{10} x = .0743$ what is x?

- What would be the required voltage of battery to read 1.9 volts across R?

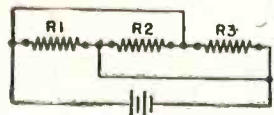

- $\sqrt{\pi}$
- Base of the natural system of logarithms.
- At 77 F. what would be the resistance of 64 feet of B and S gauge No. 25 bare copper wire?
- If an A.C. generator has an R.M.S. output of 2.4 volts, what is its peak output?

See page 669 for answers

RADIO-CONDITIONED ROOMS?

Radio may be piped into our rooms through the same ducts as treated air in postwar room-conditioning units, suggests a manufacturer of grilles for air-conditioning equipment. Loud-speakers mounted behind the grilles would be excellently placed to supply music to the room. Incidentally, units so placed would be in perfect atmospheric surroundings, which would prolong their life.

G-E TUBE CHECKER

Quick, easy, accurate tube checking which saves you time and trouble and keeps your customers happy—that's the job the TC-3P is built to do. Line Voltage and tube quality, or shorts, may all be checked on one selector switch. Individually operated switches permit placing the proper voltage on the proper pin of the tube. The G-E Tube Checker is available in either the Portable (TC-3P) or Counter Model (TC-3). Write: Electronics Department, General Electric, Schenectady, N. Y.

GENERAL ELECTRIC

177-D1

Electronic Measuring
Instruments

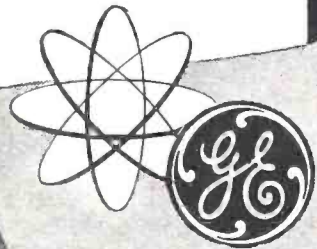
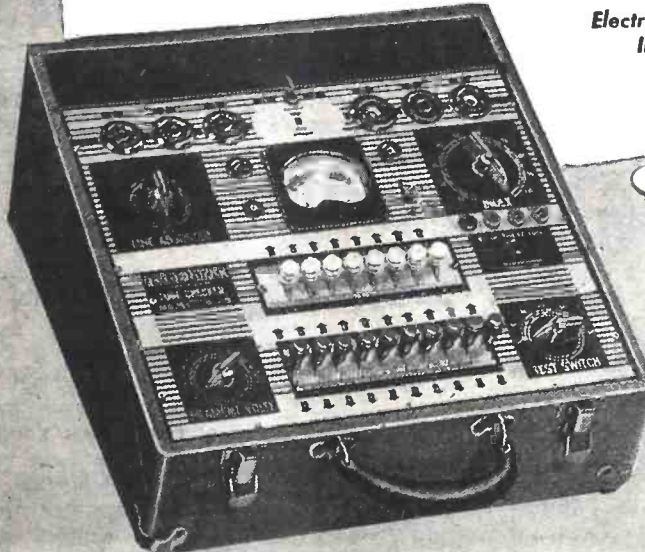

TC-3P



THERMOSTATIC METAL TYPE DELAY RELAYS PROVIDE DELAYS RANGING FROM 1 TO 120 SECONDS

Other important features include:—

- Compensated for ambient temperature changes from -40° to $110^\circ F$.
- Contact ratings up to 115V-10a AC.
- Hermetically sealed — not affected by altitude, moisture or other climate changes . . . Explosion-proof.
- Octal radio base for easy replacement.
- Compact, light, rugged, inexpensive.
- Circuits available: SPST Normally Open; SPST Normally Closed.

WHAT'S YOUR PROBLEM? Send for "Special Problem Sheet" and Descriptive Bulletin.

AMPERITE CO. 561 BROADWAY
NEW YORK 12, N. Y.

In Canada: Atlas Radio Corp., Ltd.
560 King St. W., Toronto

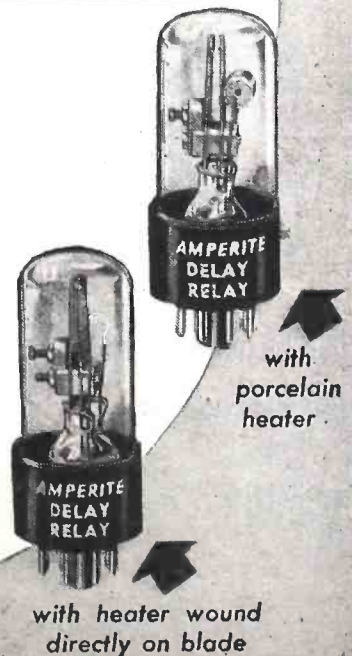



● Especially handy for compact radio or electronic assemblies, Type 14 Aerovox vertical-mounting oil capacitors enjoy widespread popularity. Recommended for high-voltage filter circuits such as cathode-ray tube power supplies, and for high-voltage by-pass circuits in transmitters and public-address equipment.

Meet the higher-voltage operating requirements, especially at high altitudes. Immersion-proof one-piece molded bakelite pillar insulator and cap, for maximum spacing between live terminal and grounded can. Upright or inverted mounting. 2000 and 3000 v. D.C.W. .01 to .25 mfd.

● See Our Jobber . . .

Ask him about your capacitor needs. Ask for latest catalog. Also for free subscription to the monthly Aerovox Research Worker. Or write us direct.



AEROVOX CORP., NEW BEDFORD, MASS., U. S. A.
 In Canada: AEROVOX CANADA LTD., HAMILTON, ONT.
 Export: 13 E. 40 ST., NEW YORK 16, N. Y. Cable: 'ARLAB'

WORK BENCH FOR THE APARTMENT

By SAMUEL COHEN

THIS movable work and test bench was made from an old radio cabinet. It takes up very little space and can be plugged into any available outlet. The meters and neon lamp are thus always on hand, as well as tools and the soldering iron. The house electric circuit is protected from shorts by fuses on the bench.

The top of the old radio cabinet is removed in one piece and sawed to fit the inside of the cabinet. When sawing, be sure to cut both bevels from the ends. Two runners or slides ($\frac{3}{4}$ " x 6" x depth of cabinet) are screwed on to the cut ends of the top and the screws countersunk. This board is your movable work bench. The slides should ride on the bottom board of the cabinet. Cut two other pieces of wood $\frac{3}{4}$ " x 8" x depth of cabinet and screw them on the left and right insides of the cabinet, above the movable shelf, as guides and holders. Be sure to leave $\frac{1}{16}$ " space between the holders and the movable work bench, so that it can slide easily. To these holders, two-hole BX saddles should be screwed in one line, to hold various tools, such as pliers, screwdrivers, etc. Between the bench and the bottom board of the cabinet, boxes (cigar boxes are ideal) can be built to hold resistors, condensers and various other spare parts.

On the right side (outside) of the bench mount a single-gang male receptacle for the incoming feed line and hook it up with drop cord equipped with plug and connector at the ends. Next connect a double pole snap or toggle switch and place a five ampere fuse and fuse outlet in series with the live leg of the line or a fuse in each side of the line. Connect up two duplex outlets, so you can plug in a soldering iron, test set, etc., with full line voltage. In the panel above the cabinet, screw on a socket with a neon glow lamp and wire it in series with the live leg, terminating with an insulated test lead. Bring up a wire from the ground lead and terminate it with an insulated test lead. This can be used for your continuity testing. Mount your meters into the panels and install pin-jacks for test leads or connect. Get a piece of sheet iron approximately 8 inches by 16 inches, 18-gage or heavier and fold it about 2 inches along the 16-inch side at right angles. Make holes

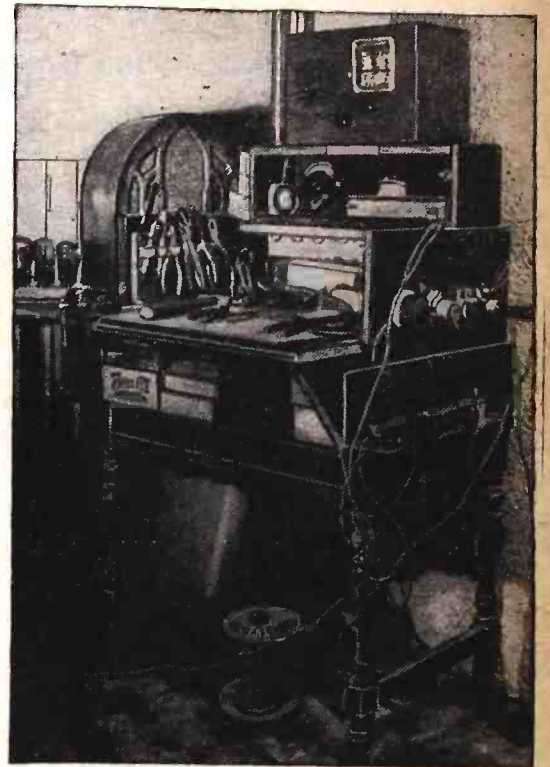

and screw it on the side under the switch and outlets. Mount soldering iron holder and stop in place.

Numerous other features can be added to suit the need of the student or experimenter. When completed it makes an excellent work bench that anyone would be proud to own.

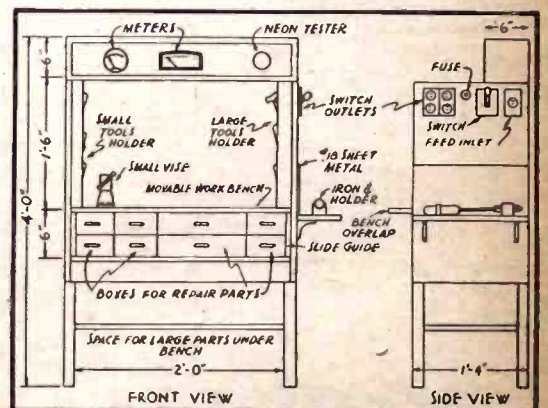

MOBILE COMMUNICATIONS OVER 82 YEARS



The two-wheeled telegraph cart dates back to 1863. It was succeeded in 1907 by a 1-cylinder Cadillac. The modern unit (right) is a complete mobile station, Hallicrafters SCR-299.

MICROWAVES

(Continued from page 624)

where a large degree of privacy is desirable. The privacy of beamed microwaves is so great that it is comparable to talking over the telephone. A few of the tubes have already been partially released, and include the Sperry Klystron and the General Electric Lighthouse tubes. Two articles on the Klystron by the author have previously been published in *Radio-Craft*.

WHERE THE HAM COMES IN

Naturally, the amateur wants to know just where he fits into the picture. In the past, "hams" have been a good market for radio parts, and have been responsible for arousing a great deal of interest in radio among people who previously thought of it only in terms of turning on a switch and listening to a program. He is responsible to a large degree for the advancement of this science since its very introduction. There are agencies looking out for the interests of the "hams" in Washington, and sections of the microwave band will be made available for amateur use after the present restrictions are removed. Soon the day should come when the amateur will again be able to have his demands supplied, and at costs that will be considerably lower than ever before. In addition to the fields he is already familiar with, microwaves should be within reach of his pocketbook. The radio industry has been greatly expanded as a result of the demands of war, and it is reasonable to assume that these plants which have expanded or opened will want to continue as much production as there is demand for. Considerable competition and low prices should result. This will benefit the amateur, because he gets no financial return on his radio investment, and is, therefore, limited as to the amount he can afford to spend.

Microwave parts production is tremendous. A large postwar market is necessary, or these plants must close. The "ham" will be able to buy those items he needs, which will probably be designed with sufficient latitude to cover an entire ham band, and by adept use of a hacksaw, pipe, sheet metal, and a few other readily available and cheap items, can construct for himself the other items he needs. Circuits are simple—note the Klystron hookup of Fig. 2. In addition to reducing the expense, this will stir up more interest in him, because most of the kick is the "tinkering" and experimenting, and there is great satisfaction of having produced something with one's own hands. If things don't work out the first time, a challenge is presented that is far from insurmountable, and a few inches of pipe or sheet metal are so inexpensive that the experimenter is not deterred from beginning again. Microwaves furnish a wider field for the amateur and experimenter than any of the others he has so successfully explored in the past.

HIGH-FREQUENCY HEATING

By a regrettable oversight, the credit line for the illustrations for the article, "High-Frequency Heating at a Glance" on page 510 of our May issue, was omitted. These illustrations were from the free booklet, "The ABC of Electronic Heating" published by the Scientific Electronic Division of the "S" Corrugated Quenched Gap Co., manufacturers of high-frequency heating equipment of Garfield, New Jersey.

Now...ALIGNING TOOLS AVAILABLE TO DEALERS & SERVICEMEN



G-C INSULATED ALIGNING WRENCHES

Made of Bone Fibre Tubing, Hexed full length inside, so end of wrench can be cut off when worn out, and tool is as good as new again.

No.	Length	Hex size across flats	Out-side Diam.	Price
No. 5051	5"	5/16"	7/16"	\$0.18
No. 5052	5"	1/4"	3/8"	.15
No. 5053	6"	1/4"	3/8"	.15
No. 5054	8"	1/4"	3/8"	.18
No. 5055	12"	1/4"	3/8"	.24



G-C WRENCH AND SCREW DRIVER ALIGNING TOOL

Made of 7/32" Bone Fibre with 1/4" Hex Wrench on 1 end and Screw Driver with metal nib on other end.

No. 5013 Price \$0.45



INSULATED HEX WRENCH AND SCREW DRIVER

Combination hex wrench and insulated screw driver. The screw driver may be extended from handle to provide extra long length.

No. 5005 extends from 7-13" Price \$0.45
5006 extends from 11-17" 0.57



G-C ALLIGATOR WRENCH AND SCREW DRIVER

For RCA-Phileo and others. Made of 7/32" Bone Fibre and strong metal wrench on 1 end and metal screw driver tip on other end.

No. 5011 Price \$0.30



NO-METAL INSUL. ADJUSTMENT SCREW DRIVER

Made of Black Bone fibre. Indispensable for aligning all-wave sets. Will give long service. Ends can be re-ground.

No. 5004-7" long Price \$0.24



G-C No. 5015 ALIGNMENT TOOL

Made of Bone Fibre, combination tool. Consists of Screw Driver with Metal nib, 5/16" Hex Wrench, 1/4" Hex Wrench slotted, with metal screw driver on one end.

No. 5015 Price \$0.81



G-C FLEXI-DRIVER

"Around the corner" Screw driver for Radio work. Insulated tips prevent "shorts" and guide the blade over screws for easy tuning. Approved by U. S. Army and Navy.

No. 5019 Price \$1.35



G-C No. 5014 ALIGNMENT TOOL

Made of Bone Fibre, combination tool. Consists of Screw Driver with metal nib, 1/4" Hex Wrench slotted and 5/16" Hex Wrench on other end.

No. 5014 Price \$0.60



G-C No. 5016 ALIGNMENT TOOL

Made of Bone Fibre combination tool that can be used for most purposes. Consists of Screw Driver with metal nib, 5/16" Hex wrench, 1/4" Hex side wrench and 1/4" Hex end wrench slotted.

No. 5016 Price \$0.81

MAIL OR PHONE YOUR ORDER NOW!

RADIO ELECTRIC SERVICE CO.
OF PENNSYLVANIA
N.W. COR. 7th & ARCH STS.
PHILADELPHIA 6, PENNA.

Phone:—
LOMBARD 6177
LOMBARD 1951

HALLICRAFTERS ★ HALLICRAFTERS ★

RECEIVER HEADQUARTERS for the Nation



BEFORE the war Bob Henry served the amateurs as the world's largest distributor of communications receivers.

Now Henry Radio is Hallicrafters receiver headquarters for the Nation at war. Hallicrafters Receivers can be supplied on priority. I can usually supply SX28As at \$223.00, S-39s at \$110.00, S20Rs at \$60.00, SX-25s at \$94.50, and PM-23 speakers at \$15.00 at once. It takes longer to supply other models.

Soon, it is hoped, non-priority orders can be filled and Bob Henry can become again Hallicrafters headquarters for the nation at peace.

I have stores at Butler, Missouri, and at 2335 Westwood Blvd., Los Angeles 25, Calif.

Your orders and inquiries are invited.

Bob Henry, W9ARA
HENRY RADIO SHOPS

Butler, Mo. and Los Angeles, 25, Calif.

"WORLD'S LARGEST DISTRIBUTOR OF COMMUNICATIONS RECEIVERS"



BUFFALO RADIO SUPPLY

219-221 GENESEE ST., DEPT. C
BUFFALO 3, N. Y.

All types of radio tubes in stock almost all the time. Mail in your orders for all types needed, not just the critical numbers, and we'll try to fill them completely, at regular dealer's cost. Hytron-Fordom-General Electric-Ken-Rad. We also have all kinds of ballast tubes in stock.

6.3 volt power transformers (No. 5 V.), with 120 volt primary and high tension\$1.50

2 1/2" METERS

WESTINGHOUSE or GRUEN 150 Microamp. D. C.\$9.95
WESTINGHOUSE 100 Milliampere D.C. 4.50
WESTINGHOUSE 300 Milliampere D.C. 4.50
WESTINGHOUSE 9 Ampere A.C. or D.C. thermocouple type, special linear scale from 1 to 9 Amperes instead of usual crowded scale. The perfect meter for appliance testing. 16.00

3 1/2" METERS

GENERAL ELECTRIC 500 MICROAMPERE D.C. with 0 to 20 KV SCALE. This meter makes a perfect 2000 ohm per volt multitester meter. With a 100 ohm resistor as shunt it makes a perfect replacement for any 1000 ohm per volt meter\$16.50
Multiplier Kit for 20, 200, 400, 2000 V., for above 2.00
General Electric 15 Volt A.C. meter 9.00
General Electric 150 Volt A.C. 11.00
GENERAL ELECTRIC 200 Milliamp. D. C. . . . 9.00
GENERAL ELECTRIC Zero Center 50 Milliamp D.C. 9.00
ALL TYPES OF METER RECTIFIERS IN STOCK

HEXACON 100 Watt Soldermaster, Professional Radiomen's Soldering Irons 2.50

WIRE WOUND RESISTORS

25 Watt: 150, 700, 3500, 5500 ohm. each.... .15
50 Watt: 15, 500, 800, 1750, 10M, 12500, 15M, or 12 Meg.20
Dual 20 MFD, 150 Volt Condensers, 1 yr. guarantee28
10 Mfd., 150 Volt Condensers, 1 year guarantee 15
Trimm Professional 4000 Ohm Headsets..... 2.75
Trimm Dependable 2000 Ohm Headsets 2.25
Trimm Rex 2000 Ohm Headsets 1.50
Trimm Acme Deluxe 1000 Ohm Single Headsets 1.00
4 Pole Double Throw, 2 to 30 V. D.C. Sensitive Relays Originally cost \$6.10 apiece, extra special, only 1.00
4 Pole (3 make, 1 breaks) 400 Ohm A.C. or D.C. relays suitable for use in plate circuit of tube as in Photocell amplifier 1.00
Single Pole Single Throw 15 Ohm A.C. or D.C. relays, normally open45

Include signed rating such as (L-265 & Signature) which all repairmen are entitled to; if possible.

No orders shipped for less than \$3.00.

Fed McElroy

World's Largest Manufacturer of
Wireless Telegraphic Apparatus
COMPLETE CENTRAL OFFICE EQUIPMENT

McElroy Manufacturing Corp.
82 Brookline Avenue • Boston, Massachusetts

In the Rocky Mountain Region
it's

RADIO & TELEVISION SUPPLY CO.
806 EUCLID AVE., PUEBLO, COLO.

"If we don't have it, we'll get it—
or it can't be had! Phone 5729"

★ BUY AN EXTRA WAR BOND ★

REPAIRS WITH RESISTORS

(Continued from page 637)

In a typical case, the sum of R_1 and R_2 may be 250,000 ohms. If a signal voltage of 5 is applied, the current through R_1 and R_2 —assuming R_L is of infinite resistance—will be:

$$I = \frac{E}{R} = \frac{5}{250,000} = .00002 \text{ amp.}$$

The dissipated power is:

$P = EI = 5 \times .00002 = .0001$ watt
Such a control may be made small in size because of the small power. In general, when signal currents alone flow through the control the power rating need not be large, but when D.C. flows through the resistor the control must be a higher-power type. A typical circuit is Fig. 3. At low volume of the receiver, the bias on the R.F. tube is at a maximum and the input resistance R_1 is then low and the D.C. voltage across R_2 and R_3 is high. In some controls R_3 is built into the control itself. In replacing it with an ordinary type not having R_3 built in, an external resistor is used, usually rated at about 1/2 watt and 200 or 300 ohms. This resistor establishes a minimum bias on the R.F. tube to prevent overloading in the presence of a strong input signal.

If the cathode current of the tube is known, and the bias voltage, the power is EI . Assuming a maximum bias of 22 volts, and that R_2 and R_3 are one, the sum of R_2 and R_3 is, for a cathode current of 5 milliamperes:

$$R = \frac{E}{I} = \frac{22}{.005} = 4400 \text{ ohms}$$

However, the cathode current drops as the bias is increased and the value may be as low as 1 ma. Then, E/I equals 22/.001 or 22,000 ohms. In practice the control may have a maximum resistance of 25,000 ohms. Assuming 1 ma. through the 22,000 ohms, the voltage is 22. Then, P equals EI or $22 \times .001$. This equals .022 watt and a rating of .05 watt would be suitable. Many servicemen never use a resistor of less than 1 watt rating, and if there is room, it is good servicing practice to use the relatively trouble-free resistors of 1/2-watt or higher rating.

BURN-OUTS FROM LINE VOLTAGE

In many A.C.-D.C. sets using the circuit of Fig. 3, one side of the line goes to chassis. This is shown in Fig. 4. The low side of the power line is often run directly to the center terminal of the control and one terminal of the on-off switch. If there is a break between 1 and 2 the filament current will pass through a section of the control. Usually, as luck will have it, the serviceman "tries" the control by rotating it and with any appreciable resistance between the arm and L_1 a good deal of power will be dissipated. Burning out the control section R_1 is common, or this section may change value and become noisy due to the overload, making the control useless. Therefore, it is always wise to check the grounding of the arm before connecting the set to the line. It is better not to depend on a nut on the control shaft to effectively ground it, but to run a wire directly to the chassis (assuming of course that the chassis ground is a part of the circuit and that a set using a "floating

ground" is not being serviced). The 0.3 amp. current passes through L_1 from the arm of the control, if section 1-2 is open. Usually, the coil can take it, and the volume control alone fails.

TUBE HEATER COMPENSATION

Resistors may often be used these days for other than routine purposes. Fig. 5 shows a typical A.C.-D.C. circuit, with the

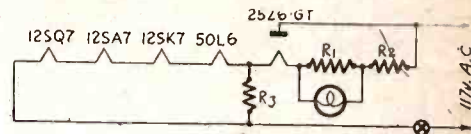

Fig. 6—Tube substitution in Fig. 5 circuit.

heater resistances in series. Fig. 6 shows the same circuit modified to take a 2526GT in place of the original 35Z5GT. The current through the pilot light is 0.15 amp. and the voltage is 6, so the "hot" resistance is $6/0.15$ or 40 ohms. A shunt rated at 40 ohms and 5 watts is suitable. A conservative wattage rating is desirable to prevent failure of the resistor should the pilot lamp burn out. The value of R_2 is determined by dividing the current through it into the voltage across it. The sum of the 12SQ7-12SA7-12SK7-50L6 drops is 86 volts. The current is 0.15 and $86/0.15$ equals 573. A 575-ohm resistor could be used, or any equivalent combination.

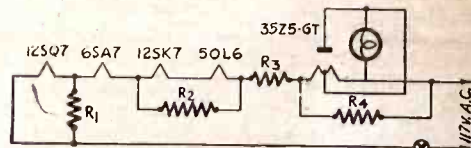

Fig. 7—Shunting to install .3-ampere tube.

The wattage of R_3 in Fig. 10 would be 86×0.15 or 12.9. A 25-watt resistor would be suitable. The total drop would be 107 volts, and, assuming a line voltage of 115 the drop across R_2 would be 8 volts. The current in R_2 is 0.3 amp. and $8/0.3$ gives 26 ohms. The rating could be 5 watts.

In Fig. 7, the use of resistors in modifying a filament circuit is further illustrated. The voltage across R_1 is 12 and the current through it is 0.15 ampere. $12/0.15$ gives 80 ohms. The power is 12×0.15 or 1.8 watt, so a wattage rating of 5 would be suitable. The drop across R_2 is 62 volts, across R_4 35 volts. The current in R_2 and R_4 in each



case is 0.15 ampere, while the current in R_3 is 0.3 amp. It is important to keep the currents straight in calculations.

PRIMARY BALLAST RESISTORS

Fig. 8 shows still another application of series resistance. Many old Majestic and other makes of receivers, and some more modern ones as well, used series resistance in the power transformer primary circuit. The value of the resistance often is unknown in servicing. The correct value may be determined experimentally. In series with the primary of the replacement transformer if one has been installed, or in series with the original transformer if it is still good, is connected a heavy duty wirewound resistor with an adjustable tap. The voltage drop across the ballast seldom exceeds 10%
(Continued on page 671)

Power Supply Stabilizing Unit

By E. A. HANNEY

THE voltage of AC lines varies all the time, by small amounts and with considerable rapidity, due to fortuitous changes in the loads connected to the system. These changes find their way to the output side of a power-pack. It is very interesting to connect a power-pack output through a blocking condenser and amplifier to a cathode-ray tube; if the amplifier has a reasonable performance down to 10 cycles or less, the output voltage will be seen to be subject to violent and random variations. It would be a bad case where the variations exceeded a fraction of a volt, but they can be a greater nuisance than slow variations of larger amount.

There are several well-known stabilizing circuits, all of which are characterized by features which have disadvantages in wartime. The output current in many cases has to be passed by a large tube, or by a battery of tubes in parallel; or gas-discharge stabilizing tubes are needed; or the load is paralleled by a large tube so that the total current always equals the full-load rating.

The circuit to be described removes almost the last trace of ripple from the output of a power-pack. At the same time it removes all but the slowest of those variations due to line voltage fluctuations.

The components needed are of standard type, easily procurable even in wartime. In essence the arrangement consists of a normal power-pack, with ordinary filtering designed to reduce the ripple of a value well within the capacity of an ordinary triode. This triode has a low plate-circuit resistance, and acts as an amplifier, giving phase reversal but neither loss nor gain.

By this means the normal ripple is neutralized.

Analysis shows that, in Fig. 1, $R_1 = 1/g_m$ where g_m is the mutual conductance of the tube. R_2 must have a tube designed to give a suitable grid bias. This value clearly depends on the fixed load current.

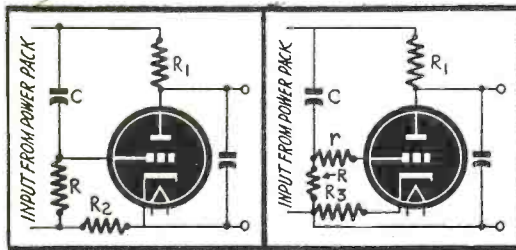

Fig. 1

Fig. 2

C should have very low leakage, and should be as large as possible, say, up to 2 microfarads; R should be 1 megohm. A large condenser or a further decoupling circuit is essential, across the output terminals, to lower the impedance presented to voltages arising in the load. For an MH4, a tube almost identical to one section of a 6N7 or equivalent tube, R_1 should be about 300 ohms, and for the best results the final adjustment of value should be made with the aid of a cathode-ray oscilloscope. Due to the presence of R_1 , the voltage regulation is made worse by about 1 volt for every 3 Ma in the load.

Fig. 2 shows a modification suitable for,

say, a laboratory power-pack which may be used on various fixed loads without further adjustment. The performance is independent of the load, but this is at the expense of voltage regulation. R_1 should now have a value of $1/g_m + R_3 (1 + 1/\mu)$. Using an MH4 or its American equivalent, R_3 can be 750 ohms, and R_1 will have to be 1,070 ohms. But again, for best results, adjustment should be made by the use of a cathode-ray oscilloscope. The resistance r is included to limit grid current when the load is suddenly increased; it can be 50,000 ohms. The voltage regulation is here made worse by about 1 volt for every milliamperere in the load.

In both these circuits there is little objection in using output voltages up to 350. The tube is not likely to be damaged so long as the plate dissipation is kept below 2.5 watts, because the plate voltage variation is small.

The author's examples built to these circuits have shown a residual ripple of not more than one millivolt in 300 volts. Moreover, the random jumpiness of output voltage has completely disappeared.

The chief application has been the supply to oscillators. In this case the oscillator portion of the instrument is connected to the semi-stabilized output, while the plate circuit, grid circuit and cathode circuit of the power stage are connected to the unstabilized power-pack direct; the chassis and case are also, for safety, connected to the negative end of the power stage supply, and to one output terminal.

From *Wireless World*, London, England, April, 1945.

FIX ANY RADIO

Amazing New Invention

**Simplified
Radio
Servicing**

NEW
1945 EDITION

REPAIR ANY RADIO IN MINUTES

Learn time-saving trouble-shooting short-cuts; find any radio fault with ease. Follow the tests shown on 24 large circuit blueprints. Over 1,000 practical repair hints. Hundreds of simplified tests using a 5c resistor and any filter condenser. Introductory material for beginners and to serve as review for experienced radio men. Several chapters on test equipment. Complete plan in manual form, 64 job-sheets, data on all tubes, size: 8½ x 11 inches. Sold on no-risk trial. Money-back guarantee. Use coupon to order →

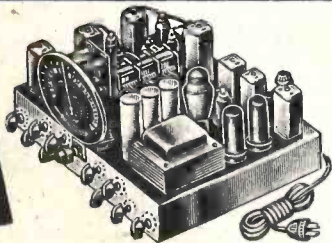

This newly developed method tells you how to locate the source of trouble in any radio without equipment. Make needed tests, measure voltage, trace the signal, by using only a 5c resistor, small condenser, and a crystal detector. Inject signals without any signal generator. Test parts by the new Comparison method. Test tubes without equipment. Repair any radio expertly following illustrated, simplified plans. Improve your radio servicing ability. Data on all sets, portables, AC-DC, FM, recorders, intercoms, P.A. Examine and apply the plan for 10 days without obligation or risk. Send coupon today →

Find radio faults with a new simplified method. Repair radios in minutes instead of hours. Revolutionary, different Comparison technique permits you to do expert work almost immediately. Most repairs can be made without test equipment. Simple point-to-point, cross-reference, circuit suggestions locate faults quickly and easily. You may try this unique plan without risk or obligation.



Developed by
M. N. Beitman,
radio engineer,
teacher, author,
& serviceman.

COMPLETE PLAN

\$1.50

TRIAL ORDER COUPON

Supreme Publications

PUBLISHERS OF RADIO BOOKS, MANUALS, AND DIAGRAMS

9 S. Kedzie Ave.

Chicago 12, Illinois

Ship postpaid the new complete Simplified Radio Servicing manual for 10 days' examination. I am enclosing \$1.50, full price. I must be entirely satisfied or you will refund my total remittance.

NAME:

ADDRESS:

ALLEN Key Kits

Key Assortments to fit Hex-Socket Screws in the range of sizes the radio mechanic needs for everyday work.

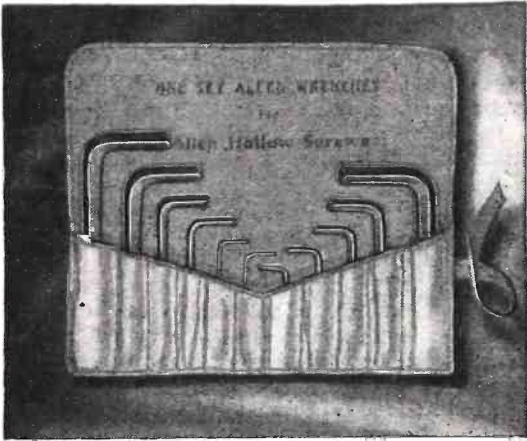

KEY SET No. 603: This canvas partitioned bag contains 11 short arm hexagonal keys which fit all screws from and including No. 10 up to and including 1/4" diameter set screws. List price \$1.75.

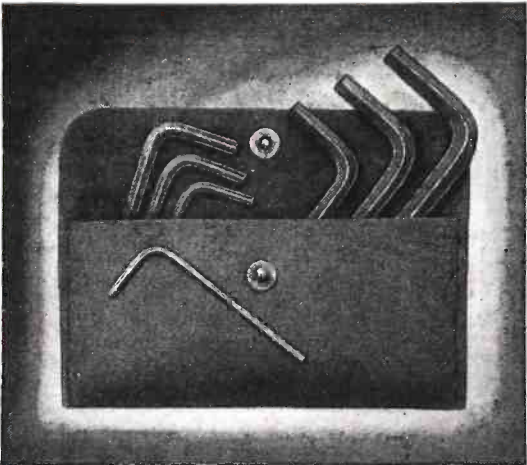

JUNIOR KEY KIT No. 604: Seven short-arm Allen Keys are included in this strong leatherette envelope. They fit the hex holes of sizes Nos. 8, 10, 1/4", 5/16", 3/8", 7/16" and 1/2" set screws and Nos. 4, 5, 6, 8, 10, also 1/4" and 5/16" cap screws. List price \$0.50.

KEY ISLAND

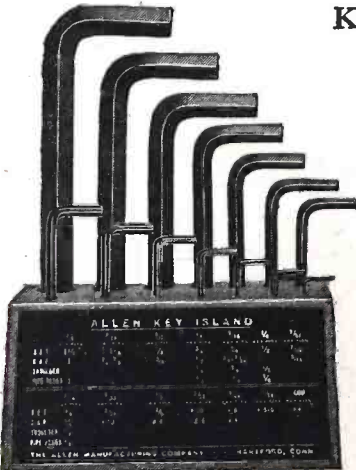

This handy key set contains 14 keys fitting all sizes of set screws up to and including 1/4"; cap screws up to 1"; shoulder screws to 1" and pipe plugs to 1". Container is plainly labeled to show the correct size key to use with each screw. No. 615; list price \$2.35.

Ask for complete listings of Allen Hollow Screw Assortments and Key Kits. Address inquiries and orders to Dep't. E,

**THE ALLEN MFG. CO.,
HARTFORD 1, CONN., U. S. A.**

PARASITIC OSCILLATIONS

(Continued from page 631)

conductances of 9000 and 5000 micromhos respectively. They were designed for television use, and the former has the highest gain of any commercially-available receiving tube. Being originally intended as video amplifiers, less attention was paid to holding the grid-plate capacity of these tubes to a minimum, and as a result it ranges around .015 mmfd., or about five times as great as that of a 6SK7. This characteristic combined with their high gain make these tubes very susceptible to parasitic oscillation. In fact the 6AC7 may be just about ruled out for low frequency, high-efficiency applications, as sufficient feedback to sustain oscillation is almost inevitable. The 6AB7 may be used with success but extra-special care must be taken in the design and construction of associate circuits. These tubes are exceedingly tricky, so watch out when you use them. For more stable and reliable operation, the 6SG7, a single-ended metal tube, is an excellent choice. This tube, with its loktal counterpart, the 7G7/1232, has a transconductance of around 4000 micromhos and a grid-plate capacity of about the same as the 6K7. While their extra gain necessitates extra care in feedback elimination, it is nevertheless quite possible to use them at voltages chosen to realize maximum gain.

If U.H.F. amplification is required, other problems enter the picture, such as dielectric losses in the tube, lead lengths (which may present appreciable inductance at U.H.F.), and input and output capacitances (which become appreciable factors at such frequencies). In general, the merit of a tube as a U.H.F. amplifier is determined by its transconductance and by its inherent losses, which include both dielectric losses, lead inductance, and input and output capacities. The 6AC7 and 6AB7 are therefore very useful on the U.H.F., since lead length and dielectric losses are low and the input and output capacities (which are rather high compared to other U.H.F. types) are amply made up for by the very high gain. Other U.H.F. amplifiers for receivers are the 956, representing the acorn types, and the more recent 9002. These tubes have a transconductance of the same order as the 6K7, but their special low-loss construction allows them to give results on the U.H.F. comparable with the higher gain 6AC7 and 6AB7, besides being a lot easier to handle. The 6SG7 and 7G7/1232 are also very good on the U.H.F., having been designed with such operation in mind, and the low-loss construction of the 6SK7 allows it to be used with some degree of success, especially in the I.F. systems of F.M. receivers.

Finally we have a small group of tubes designed primarily for battery broadcast portables. They all have 1.4 volt, .05 ampere directly-heated cathodes and very similar characteristics, including an exceedingly low grid-plate transconductance—approximately 550 micromhos. The IN5-G or IN5-GT is the octal-based type, while the 12N5 is its octal counterpart and the IT4 is the miniature style. A lack of proper shielding makes them rather susceptible to parasitics in spite of their low gain, and in general it is advised to stay clear of these tubes if you want a good set, unless a dry battery power supply is the only kind available.

In designing a set, the general lineup of the circuits and tubes should be first determined before actual attention to cir-

cuit details is given. There is a limit to the number of practically usable stages. This limit is determined principally by noise considerations and by the usable gain which may be realized. After a certain point, addition of further amplifying stages will not noticeably increase the receiver's sensitivity, and become more of a liability than an asset, since tuning becomes critical, the receiver's noise level increases, and each additional stage makes the problem of adequate feed-back elimination just that much more difficult.

In regard to I.F. amplifiers, a single stage using proper design will deliver plenty of gain for most purposes. The 6K7, 7B7, 6SK7, and the 7A7 make very satisfactory I.F. stages for I.F.'s of 175 to 1600 Kc., while higher gain may be realized from the 6SG7. The 7G7/1232 will tend to overload in an I.F. amplifier, and the television pentodes are almost sure to oscillate. For extra gain and selectivity, two I.F. stages may be used, and with very careful design you can make three operate with justifiable efficiency. The more reliable tubes such as the 6SK7 should be used in the latter cases, since I.F. circuits display very high gain in the tuning and coupling circuits, especially if high quality iron-core I.F. transformers are used, thereby making the minimum feedback required to sustain a parasitic that much lower. There will never be a case where more than three I.F. stages are justified, even if one of them is a noise-silencer and therefore contributes less gain. Such stages, in fact, should be watched exceptionally carefully, since, in spite of their lower gain, the presence of extra feedback paths in the associated circuits makes them especially subject to parasitics.

A single stage of R.F. amplification preceding the first detector is to be very highly recommended because of the gain, selectivity, and image rejection which it adds to the set. Any of the R.F. tubes described previously with the exception of the 6AC7 may be used with success in a broadcast or all-wave receiver. Two R.F. stages may also be used, but again there will never be a case justifying the use of more than this number. If two R.F.'s are desired, it is well to make at least the second one a tube from the lower transconductance group—the 6K7 and 6SK7 group—rather than using ultra high



Suggested by Thomas Jewell, Clyde, Ohio

"You know I miss the noise and excitement of the 4th of July."

gain types in both positions. These rules, let it be noted, apply to receivers operating on frequencies below 40 mc., for above this frequency further problems are encountered. For U.H.F. superheterodynes such as those used in F.M. and television work and having I.F.'s of 3 mc. and more, gain to overcome noise and losses is the primary consideration. These losses and the fact that tuned circuits on the high frequencies display far less efficiency than those on lower bands allow the use of any of the very high transconductance pentodes. The 6AC7 has proven itself a very excellent amplifier on these frequencies—although special care must be used in handling it—as the reactance of the grid-plate capacity is lower at the higher frequencies and hence less additional feedback is required for oscillation.

End of Part I

BATTLE RADIO TRICKS

(Continued from page 638)

W-110 wire made into a cable, we found that we could extend the "mike" wire down to the basement to the operator.

FLYING RELAY STATIONS

A secondary and very important use of our liaison planes was to have them cruise on patrol with their radio on the battalion's common channel and act as a relay station. Thus, if a forward observer ever did get into a well masked area where line-of-sight transmission was impossible, or in a very fast-moving situation where the forward observer or S-2 gets 'way ahead of the unit, he can still have communications with his unit through plane relay. This relay became so important that in some cases the planes would go up with relaying as their primary duty, since visibility was so poor that it would have been useless to send a plane up for observation purposes alone.

Complete wire communications, however, should still be the end toward which all communications sections should work. A conversation carried on by radio must be limited, whereas the person-to-person telephone conversation is more flexible. But to put the initial installation in and to keep it constantly serviced necessitates sending men out under constant hostile fire. Therefore, when it is installed it must be put in carefully and over a well reconnoitered route. Hasty and prolific wire laying is foolish as it increases the servicing of a wire a hundredfold. Trunk lines should if possible go overhead and out of the way of tracked vehicles and impact bursts. Lines to forward positions (such as liaison officers and forward observation posts) must be on the ground, preferably in ditches in order to facilitate their servicing. These forward lines are constantly being broken by mortar and artillery fire, and linesmen should have

some protection when going out. We also found that by putting in a forward switchboard that took care of the liaison and forward observer lines primarily, we could shorten the trouble-shooting time on these lines, since it provided the forward people with an additional crew for trouble-shooting. Two lines from our forward board to the rear board were sufficient to handle the traffic.

RADIO GETS IN MILADY'S HAIR!

THE proverbial lady who spends so much of her time at the beauty parlor will be happy to discover that the process need

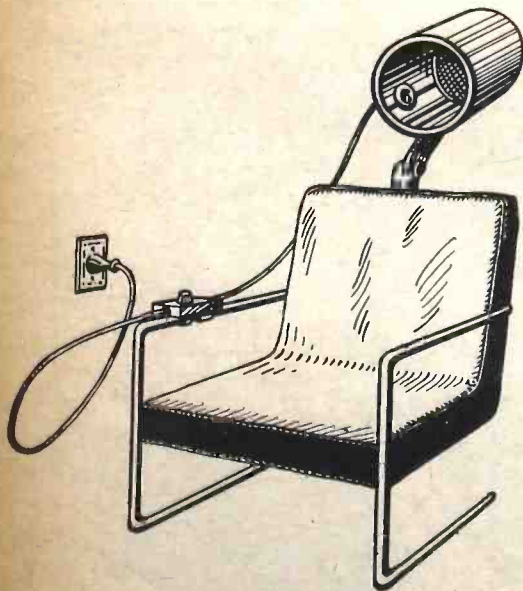

In undergoing "drying" treatment, a large bell is usually placed over the customer's head. Clear hearing of outside sounds is not possible. Added unpleasantness results from the inclusion of a fan inside the bell.

The usual drying bell is altered in this invention to include a receiver mounted within a soft rubber ring for milady's comfort. Connecting wires lead to a volume control mounted on an arm of the chair and thence to a wall outlet. Internal wiring may then lead to a central source which may be a radio or phonograph. The ear-piece is insulated by rubber mounting from direct contact with the bell so that resonance effects are eliminated. The invention is patented by Marvin E. McCart of San Jose, Cal.

In time to come, rush hour at the beauty parlor may mean another Frank Sinatra program.

DYING NAZIS' MESSAGE

Dying gasp of Nazi radio High Command communiqué, transmitted May 8, was: "The ban on listening to foreign stations has been lifted."

(That makes it unanimous!—Editor)

Electricity

Models range from 350 to 35,000 watts, A. C. types from 115 to 660 volts, 50, 60, 180 cycles, single or three-phase and 400, 500 and 800 cycles, single phase. D. C. types from 6 to 4000 volts. Also available in dual voltage and special frequency types.

ONAN

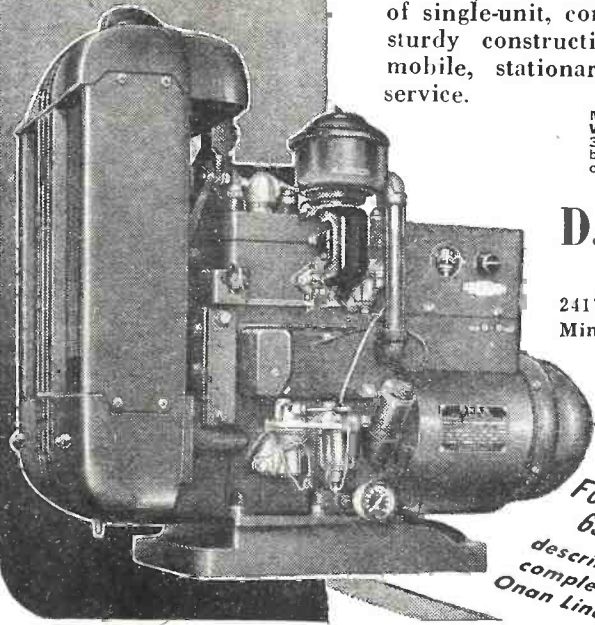

FOR RADIO AND ELECTRONIC APPLICATIONS

ONAN ELECTRIC GENERATING PLANTS supply reliable, economical electrical service for electronics and television applications as well as for scores of general uses. Driven by Onan-built, 4-cycle gasoline engines, these power units are of single-unit, compact design and sturdy construction. Suitable for mobile, stationary or emergency service.

Model shown is from W2C series; 2000 to 3500 watts; powered by Onan-built, two-cylinder, water-cooled engine.

D. W. ONAN AND SONS

2417 Royalston Avenue
Minneapolis 5 Minn.

Write For Folder 690-A describing complete Onan Line

IMMEDIATE DELIVERY RADIO PARTS

6 ft. cord sets—high grade—soldered—molded rubber plug at one end. 10 for \$2.75. Each 29c
Mike Cable—superior quality, single conductor, shielded pre-war quality natural rubber cover. Per ft., only 8c
Dual conductor as above. Per ft. 10c
Carbon Resistor Kit No. 16, 100 RMA coded, 1/2 and 1 Watt, assorted. Our price, only \$2.94
Aerial Kit, containing aerial wire, insulators, rubber-covered lead-in, ground clamp, window strip, complete set, only 89c
10 MFD 50 WV Tubular Pigtail Electrolytic Condensers. Year guarantee. 10 for \$2.25. Each, only 24c
20 MFD 150 WV Tubular Pigtail Electrolytic Condensers. Guaranteed one year. 10 for \$3.30. Each 35c
10 MFD 450 WV Tubular Pigtail Electrolytic Condensers. Year guarantee. 10 for \$3.95. Each 43c
20-20 MFD 150 WV Tubular Pigtail Electrolytic Condenser. Year Guarantee. Each 59c
EXTRA SPECIAL Heavy Duty C.D. Pyranol 8 MFD 600 WV (900 pk) oil-filled paper filter-condenser in hermetically sealed metal container . . . 3 x 4 1/2 x 1 inch with connections through ceramic bushings. List price \$9.80. Our price, only \$3.30
Bakelite Set-Screw Knobs. DeLuxe assortment of 50 for 1/4 inch shaft \$3.93
of hard-to-get parts, supplies and sound equipment.
Write for latest bargain bulletin

LIFETIME SOUND EQUIPMENT CO.

DEPT. 16, TOLEDO 1, OHIO, U.S.A.

One Central Source FOR Everything in RADIO and ELECTRONICS

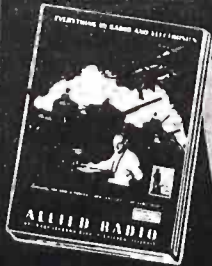

FREE Helpful BUYING GUIDE



REPAIR and REPLACEMENT PARTS AVAILABLE without priority

Over 10,000 items from all leading manufacturers . . . for the Armed Forces, Radio Training, Laboratories, Industry, Service Replacements.

Parallel Resistance and Series Capacitance **CALCULATOR**

No. X37-960 Postpaid . . . **25c**



R. F. Resonance and Coil Winding CALCULATOR
No. 37-955 Postpaid . . . **25c**



6 Radio Books for 75c

- Dictionary of Radio Terms. No. 37-751 **10c**
- Radio Data Handbook. No. 37-754 **25c**
- Radio Circuit Handbook. No. 37-753 **10c**
- Radio Builders Handbook. No. 37-750 **10c**
- Radio Formulas & Data Book. No. 37-752 **10c**
- Simplified Radio Servicing. No. 37-755 **10c**
- All Six Books No. 37-799 . . . **75c**

Write for Quantity Prices

ALLIED RADIO CORP., Dept. 2-G-5
833 W. Jackson Blvd., Chicago 7, Ill.

Please send following books (. enclosed)
 FREE Guide 37-750 37-752 37-754
 Calculator 37-955 37-751 37-753 37-755
 Calculator X37-960 No. 37-799 (All 6 Books)

Name

Address

City State

ALLIED RADIO

AN ELECTRONIC OMNICHECKER

(Continued from page 632)

CALIBRATING THE METER

Before calibration is attempted it may not be amiss to advise that one should spend some time becoming familiar with the operation of the unit.

To use the meter it is first necessary to allow it to warm up after closing switch S4. Switch S5 should also be closed during the warm-up period. This latter switch has not yet been mentioned and is really unnecessary. It can be seen in the upper left hand corner of the photograph and was installed by the author to short out the meter while changes were being incorporated—and until the author was able to obtain two matched 7A5 tubes. The switch was left in the original tester, it being thought that it would be useful at times to short out the movement and yet allow the remainder of the unit to be in operating condition.

With S5 open we may place the instrument selector switch S1 in the “+ D.C. volts” position and the meter-reverse switch S3 in the “+” position. The range selector S2 is rotated until the desired range is available. Always start with the highest voltage range to protect the meter, although possible damage here is limited owing to plate current saturation being reached at a low value. It might be well to try checking a few voltages, being sure to connect the ground or common lead to the negative terminal and using another lead into the tip of which is fitted a small 1-megohm resistor as per Figure 8 to tap onto the positive terminal.

Now we may switch S1 to the “minus D.C. volts” and S3 to the “minus” positions and reverse our test leads in connecting to the same voltage source.

To operate the A.C. vacuum-tube voltmeter fit the 5-prong plug of the diode head cable into the 5-prong socket at the side of the cabinet. This applies heater voltage to the 9002 and closes the contact potential bucking circuit. Allow sufficient time for the 9002 tube to heat up, meanwhile placing S1 in the “A.C. volts” position and S3 in the “minus” position. The range selector S2 may now be turned to the desired range.

Although 500- and 1000-volt ranges are

provided and usable here it is inadvisable to apply more than 250 volts to the diode head for any appreciable length of time due to the close spacing of elements inside this particular tube. Over 500 volts has been applied, but this is not recommended.

The vacuum-tube ohmmeter ranges are available by switching S1 to the “OHMS” position (S3 at +) whereupon the meter indicator will move up scale. Adjustment of R_B will allow exact full-scale deflection. Upon connecting the test leads across the resistor whose value is to be checked the indicator will move down scale. S2 should now be rotated until the pointer stops somewhere near the low end of the OHMS scale. This procedure is duplicated when the vacuum tube capacity meter is to be used except that S1 is set to “Capacity” and S3 is placed in the “minus” position.

CALIBRATING THE MULTITESTER

Once the instrument is completed and operates to the satisfaction of the reader it is necessary to calibrate the various ranges to insure perfect accuracy. Again it is best to begin with the D.C. voltmeter. If the resistors R_{21} through R_{20} are correct in value the procedure is simplified. To calibrate allow the unit to reach normal operating temperature and then check the zero position of the indicator by placing S1 in the “+ D.C. volts” position and moving S3 back and forth, at the same time rotating R_A until no change is noted with the indicator at exactly zero.

Applying a voltage of exactly 1.5 volts to the input terminals as shown in Fig. 8 set S3 to the “+” position and the range selector S2 to 1.5 volts. A D.C. voltmeter (V) known to be accurate is used as a standard. R_5 of Fig. 9 is adjusted until the instrument milliammeter reads exactly full scale. A check on the 10-volt range is now possible by moving S2 to that range.

This procedure is repeated for the 1.5 “minus D.C. volts” range. Here it is simply necessary to reconnect the V.T.V.M. ground lead to point “Y” rather than point “X” and adjust R_6 (Fig. 9).

Once set, R_5 and R_6 need not be touched unless a tube or part has been replaced. In the event an accurate D.C. voltmeter



Suggested by: Gus Britzman, Houston, Mo.

“Mama, my bottle is empty!”

is not available for use as a standard, it is possible to calibrate by using a new flash-light cell. Assume it has a terminal voltage of 1.5. More accurate results may be obtained by connecting a resistor of approximately 1000 ohms across the cell.

This action should be resorted to only as a last resort as normally a more fortunate radio-enthusiast will be more than happy to offer his aid—and his voltmeter.

CALIBRATING THE A.C. V.T.V.M.

The technique of calibrating the A.C. voltmeter is essentially similar to that of the D.C. voltmeter. First the contact potential should be neutralized. This procedure has already been described. Briefly, plug the Diode Head into the socket at the side of the cabinet and allow the 9002 to warm up. S1 is set to the "A.C. volts" position, S3 at "minus" and S2 at 1.5 volts. The meter will read up-scale and R₃₂ is set to reduce the meter reading to zero.

The 60-cycle voltage from a transformer filament winding is substituted for the 3-volt battery of Fig. 8. The voltmeter (V) is now a low range A.C. meter, preferably of the vane type. R₁₀ is adjusted for full scale deflection (1.5-volt range) of M and the A.C. Vacuum Tube Voltmeter will then read R.M.S. rather than peak volts.

No calibration is necessary for either the vacuum-tube ohmmeter or the vacuum-tube capacity meter but R₁₀ must be set to neutralize the 6H6-G contact potential before the latter may be used. To neutralize the contact potential, short the movable arm of S2.3 to chassis to preclude pickup of extraneous voltages and adjust the midge potentiometer R₁₀ until the meter M reads zero. If adjustment is not within the range of R₁₀, it might be wise to interchange the wiring to the 6H6-G cathodes. The shaft of R₁₀ is slotted and mounted in an out-of-the-way place as once it is adjusted with a screwdriver it need not be touched unless the 6H6-G is replaced. The accuracy of the latter functions may be checked by testing a given capacitor or resistor on more than one range and noting if the readings coincide. If this is not found to be true one or more of the standards is itself inaccurate.

In the original equipment the author has maintained an accuracy of between 1 and 2% by carefully choosing his standards: Resistors R₁₇ through R₃₀ and capacitors C₃ through C₆. Careful filing and aging, as already outlined, has been helpful in obtaining these results.

LESS SENSITIVE MOVEMENTS

While the description thus far has assumed a 1-Ma. movement, it was claimed that any movement up to and including a 5-Ma. could be used. If a 1½-Ma. movement is available, absolutely no changes are necessary since variation of R_B, R₈, R₉ and R₁₀ can be set for any movement up to 1½-Ma. To adapt the circuit for use with a 2- to 3-Ma. movement we simply change the voltage divider consisting of A₂₄ to R₃₀.

The new values are now given: R₂₄—7 megs; R₂₅—2.4 megs; R₂₃—300K; R₂₇—180K; R₂₈—60K; R₂₀—30K; R₃₀—30K. It is emphasized though, that the lowest range will now be changed to 3 volts, all other ranges being the same. This is true of both the A.C. and D.C. voltmeters. B₁ is also changed to 3 volts (2 cells).

To adapt the circuit to use a 5-Ma. meter movement, the following changes are necessary: R₂₄ is changed to 5 megohms; R₂₅ to 4 megohms; R₂₀ to 500,000 ohms; R₂₇ to 300,000; R₂₈ to 100,000; R₂₀ and R₃₀ each to 50,000 ohms. The lowest range will now increase to 5 volts for both A.C. and D.C. and again all other ranges remain the same. B₁ is increased to 6 volts by using 4 cells.

Two other changes are also necessary if a 5-Ma. movement is to be used. R₁₀ is reduced from 9830 to 9750 ohms. To obtain 9750 ohms use 10,000 and 400,000 units in parallel. Then R₅ is increased to 9000 ohms.

Fig. 9 shows values of voltage and current to be expected at various points so the reader may have a basis for comparison. Unless otherwise stated voltages are given with respect to B-minus.

The writer hopes this instrument will find a useful spot on the bench of many radio enthusiasts and in conclusion extends his invitation to correspond on any problems evolving during construction. Every letter will be given individual attention.

LIST OF PARTS

RESISTORS

- RA—Zero adjustor—2000 ohms
- RB—Ohms and Capacity Adjustor—10,000 ohms
- R1—6000 ohms ½ W
- R2—6000 ohms ½ W
- R3—200 ohms ¼ W
- R4—200 ohms ¼ W
- R5—8700 ohms 1 W (7500 ohms and 1200 ohms in series)
- R6—500,000 ohms ¼ W
- R7—9000 ohms ¼ W
- R8—3000-ohm potentiometer (slotted)
- R9—3000-ohm potentiometer (slotted)
- R10—A.C. volts calibrator, 10,000-ohm potentiometer (slotted)
- R11—4000 ohms 2 W
- R12—10,000 ohms 2 W
- R13—9830 ohms (10,000 ohms, 2 W in parallel with 600,000 1 W)
- R14—10 megohm ¼ W
- R15—10 ohms 2 W
- R16—Contact potential balancer. Midget 5 meg. pot. Shaft slotted for screwdriver adjustment.
- R17—10 ohms ¼ W
- R18—90 ohms ¼ W
- R19—900 ohms ¼ W
- R20—9000 ohms ¼ W
- R21—90,000 ohms ¼ W
- R22—900,000 ohms ¼ W
- R23—9 megohms ¼ W
- R24—8.5 megohms ¼ W
- R25—1.2 megohms ¼ W
- R26—150,000 ohms ¼ W
- R27—90,000 ohms ¼ W
- R28—30,000 ohms ¼ W
- R29—15,000 ohms ¼ W
- R30—15,000 ohms ¼ W
- R31—50 megohms ¼ W
- R32—2000 to 5000 ohms midget pot.—shaft slotted
- R33—15 ohms ½ W
- R34—2 megohms ¼ W
- R35—1 megohm ¼ W inserted in tip of test lead

CONDENSERS

- C1—.005 µf
- C2—4 µf 250-volt electrolytic
- C3—.0001 µf high grade mica
- C4—.001 µf high grade mica
- C5—.01 µf high grade mica
- C6—.1 µf high grade paper
- C7—1 µf or 2500 ohms resistor—see text
- C8—10 µf or 250 ohms resistor—see text
- C9—100 µf or 25 ohms resistor—see text
- C10—.01 µf paper
- C11—.02 µf (2-.01 units in parallel) 1000-v. high grade micas

MISCELLANEOUS

- Tubes—2—7A5's; 1—6H6G; 1—9002; 1—84
- T—Power Transformer; 250-0-250 volts; 6.3 volts C.T.; 5 volts
- S1—2-pole 5-position switch
- S2—3-gang 7-position switch
- S3—"Meter reverse" switch—DPDT toggle
- S4—On-Off power switch
- S5—Meter On-Off switch
- B1—1.5 volt flash-light cell
- B2—1.5 volt flash-light cell
- PL—5-prong plug
- So—5-prong socket
- 5—Tip-jacks—insulated
- 2—Loctal sockets
- 1—Octal socket
- 1—9002 bantam socket
- 1—5-prong socket
- Assorted hardware, etc.

A two-million dollar corporation is being formed by International Telephone and Radio Corporation solely to unite in one organization the efforts of its electronic research scientists over the world. The new concern will be called International Telecommunication Laboratories, and will build its research laboratory at Hatley, New Jersey.

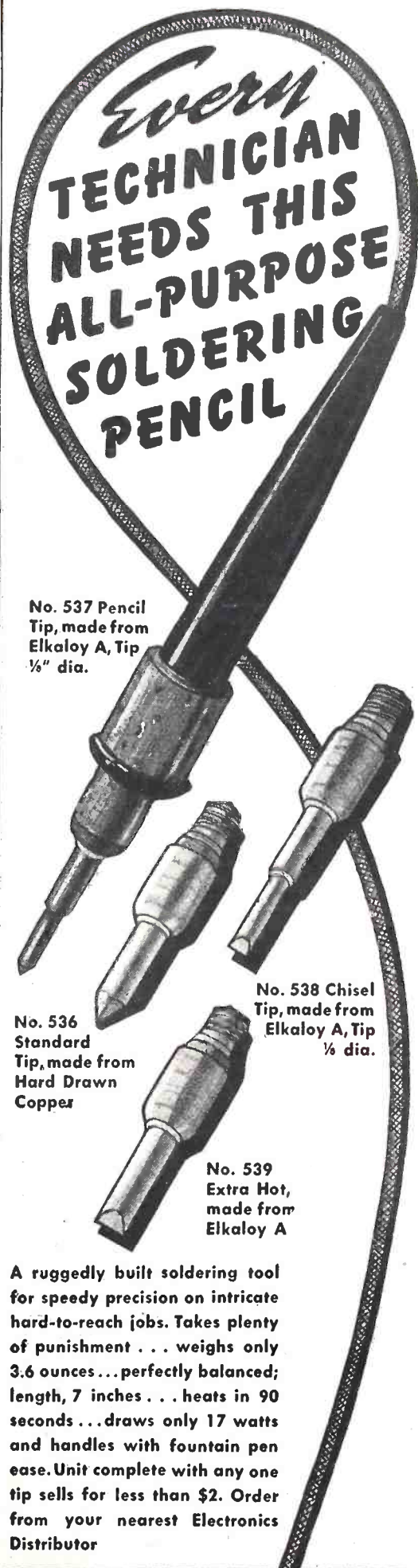

No. 537 Pencil Tip, made from Elkaloy A, Tip ¼" dia.

No. 538 Chisel Tip, made from Elkaloy A, Tip ¼" dia.

No. 536 Standard Tip, made from Hard Drawn Copper

No. 539 Extra Hot, made from Elkaloy A

A ruggedly built soldering tool for speedy precision on intricate hard-to-reach jobs. Takes plenty of punishment . . . weighs only 3.6 ounces . . . perfectly balanced; length, 7 inches . . . heats in 90 seconds . . . draws only 17 watts and handles with fountain pen ease. Unit complete with any one tip sells for less than \$2. Order from your nearest Electronics Distributor

Ungar
Electric Tools, Inc.
Formerly Harry A. Ungar, Inc.
LOS ANGELES 54, CALIF.

AMPLIFIER MANUAL

By A. C. SHANEY

Chief Engineer, Amplifier Co. of America

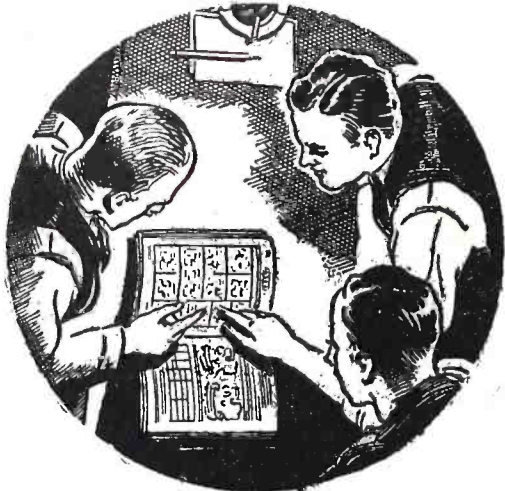

For the Layman, Serviceman
Recordist and Engineer

Regardless of whether you are interested in the finest type of phonograph reproduction, high fidelity recording, sound-on-film applications, FM or AM programs, you will find invaluable information in this practical handbook. Written by the leading exponent of direct-coupled amplifiers who has spent more than 10 years improving and perfecting the famous Loftin-White circuit.

Explains the theory and practical application of:

- Variable Speed Non-Overloading Push-Pull Expansion
- Non-Frequency Discriminating Scratch Suppression
- Push-Pull Balanced Direct-Coupled Amplification
- Push-Pull High-Frequency Equalization
- Push-Pull Low-Frequency Equalization
- Push-Pull Volume Compression
- Automatic Volume Limitation
- Automatic Volume Control
- Calibrated V. U. Indicator
- Audio Spectrum Control
- Remote Control

If you are interested in the latest audio developments, you can't afford to be without this complete compilation of authentic articles on Direct-Coupled Amplifiers. 82 pages 8 1/2" x 11". Over 100 diagrams and illustrations.

Priced to Cover Cost of Printing and Mailing **25c**
Send U. S. Stamps or Coin

AMPLIFIER CO. of AMERICA

396 BROADWAY

NEW YORK, N. Y.

FREE

TO
RADIO
MEN

COLOR CODE and
OHMS LAW CALCULATOR

Burstein-Applebee of Kansas City offers you this great convenience FREE. Easy to work. Solves many problems in a jiffy. FREE to radio men, electronic engineers and others in the business. Attach coupon to your letterhead.

MAIL COUPON NOW

BA

BURSTEIN-APPLEBEE CO.
1012 MCGEE, KANSAS CITY 6, MO.

Send me FREE Color Code and Ohms Law Calculator along with latest catalog.

I am _____
STATE CONNECTION IN INDUSTRY

NAME _____

ADDRESS _____

TOWN _____ STATE _____

A PAIR OF USEFUL CIRCUITS

By CHARLES McCLESKY, JR.

In a discussion of cathode bypassing, in an issue which I won't bother you to look up, you passed over a useful and interesting fact; namely, that $C_k = \frac{2.2 Gm}{\omega}$

for pentodes. The cathode resistor does not enter at all. (The frequency giving .8 total gain is ω .) I recommend this fact for any further articles on the subject.

Now to accentuate the positive, here is a circuit which simplifies the problems of war-time multivibrator construction (ganged identical volume controls are rare).

I give parts values for very low (10 or less cps), to perhaps 1 kc.

Values are not critical, of course.

The limitation on the circuit is the considerable grid current. This is not dangerous with a large grid resistor, or the variation of voltage can be less extreme.

Another circuit I have employed is a modulated signal generator. This I arranged to give a 60 cps square wave, so synchronization on the scope is easy.

Its value is not limited to people who have oscilloscopes.

All parts are as usual. The oscillator has several volts bias to improve the wave form.

I have been able to detect oscillations at the input level peaks, otherwise very difficult to diagnose. Also, when I get a set that has been "screwed up" and realignment is impossible, the broad spectrum

of this device is useful. The .01 condenser must have a 100-volt or higher rating. A grid leak is unnecessary (???—Editor), unless a straight amplifier is desired. I occasionally used phono, which is the explanation of the many parts on the 57.

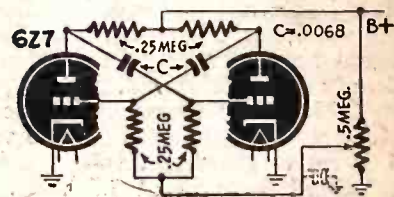

In case of oscillation, the pattern is an interrupted and distorted sine wave, or worse. Of course, an exact square wave is too much to expect from any radio, but a good one is not hard to make out.

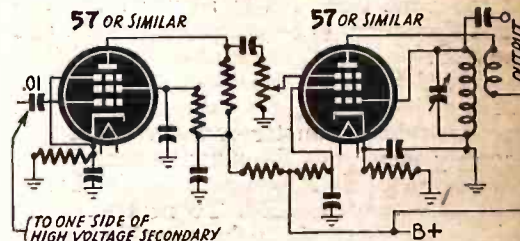

The multivibrator amplitude is fairly constant, increasing at high frequencies. This I consider an improvement over a ganged volume control, since amplitude drops off at low values of R_g and usually stops over part of the range.

LIFEBOAT RADIO (Continued from page 626)

cause of the two-way radiotelephone facilities, the men in near-by lifeboats may communicate directly with one another and thereby plot their course so as to approach rescuing craft.

In the past the antenna system used with lifeboat radio installations has consisted of a short length of wire supported by the sailing mast, and fastened to the bow and stern of the boat as an inverted "V" antenna. While satisfactory over short distances, such an antenna has limited the maximum transmission and reception range of the lifeboat apparatus.

The new installation is now equipped with a collapsed rubber balloon, hermetically sealed in a metal container, and a cylinder of compressed helium gas for inflating the balloon. The use of helium gas is an important step forward, as it eliminates the hazards of hydrogen gas sometimes used to inflate radio antenna balloons. After the balloon has been removed from the container, it may be easily connected to the helium gas cylinder and inflated in a few minutes to a diameter of four feet. Special strong, lightweight, antenna wire from the reel on the set is then attached to the balloon and the balloon released to a height of about 300 feet. The diffusion of gas through the balloon rubber fabric is extremely small so that the balloon will remain aloft for a week or more.

As a further precautionary measure, a collapsible box kite is supplied with each installation. This kite, which weighs only 13 ounces, may be quickly assembled to

carry aloft 300 feet of antenna wire under wind conditions which would not be suitable for flying the balloon.

Each lifeboat installation is equipped with a compact water-tight spare parts box which contains spare parts, tools, the helium cylinder, the balloon, and the kite. As a result, each lifeboat may be considered to have a complete radio station, which includes telephone and telegraph facilities, automatic transmission, built-in power supply, and an efficient antenna system.

The progress which has been achieved in the design of modern lifeboat radio equipment is exemplified by a comparison with one of the older models. For example, previous radio installations in the motor lifeboats of passenger vessels involved several units with a total weight of 450 pounds. Such equipment did not incorporate any shortwave facilities, required skilled radiotelegraph operating personnel, and contained no provision for radiotelephony. The new equipment weighs less than 160 pounds and includes all of the modern advances described in this article. It is so constructed that it may easily be transferred from one lifeboat to another simply by lifting the set through handles and bolting the housing to the floor of the other boat.

Relaxation of zoning regulations to permit television transmitter towers within city limits is urged by the Washington (D.C.) Post.

YESTERDAY'S CIRCUITS

(Continued from page 630)

attempts at a "one-tube loud-speaker set" used a 201A as R.F. amplifier, aperiodically coupled to a crystal detector, the A.F. output of which was amplified by the same 201A (Fig. 2). Power output to the speaker was often over 20 milliwatts—deafening volume for those days. Old-timers will remember the Grimes Inverse Duplex and Scott-Taggart's famous collection of reflex circuits. The reflex principle was revived in the middle of the thirties, when a 6B7 was employed as I.F. amplifier, diode detector and A.F. amplifier in some of the cheaper and more compact superhets. It is possible today to build a compact one-tube loud-speaker set around a 6B7 or 6B8G, using

the pentode section as R.F. amplifier and A.F. power tube—output about a third of a watt with 25,000 ohms load. One (or both) of the diodes is used as detector. By using a little regeneration surprising gain can be obtained, though much better results are obtained from an EBLi, a continental type tube that is practically equivalent to a 6AG6G (a high-mu output pentode) and a pair of diodes.

Now what of the Gernsback Interflex? It certainly has survived (or been revived) though in a very different form from its original versions, of which there were three.

Nearly every set today has in it the Interflex principle in a disguised form. The early interflex sets of around 1925 contained a crystal detector of the carborundum type in place of the conventional grid leak and detector. Their tonal quality was good (for the times in which they were used). What has become of the crystal detector? Look at the diagrams (Fig. 3). The first shows an old time interflex circuit (part of the Interflex 4). You note that the grid, crystal detector, coil and cathode are in series. In the second we put the crystal detector in between the coil and cathode—still in series and the same voltages are applied between grid and cathode. Now we replace the crystal by a diode in the third circuit and in the fourth we put the diode in the same envelope as the triode. The interflex circuit has become the diode-detector-cum-audio amplifier of, not today, but rather yesterday. The modern "detector" uses a separate bias system for the A.F. amplifier as in the fifth diagram, which, by the way gives a set of "high-fidelity" circuit constants. If a volume control is to be included it can be a 2-meg. potentiometer, substituted for the 5-megohm grid leak now shown in the diagram.

The early interflex circuits generally did not need a grid leak or condenser, relying on leakages and the capacity across the crystal detector. In some cases, a small capacity or a high resistance grid leak had to be added.

Just as the original interflex became the regenerative interflex with remarkable selectivity and volume, so regeneration can

(Continued on following page)

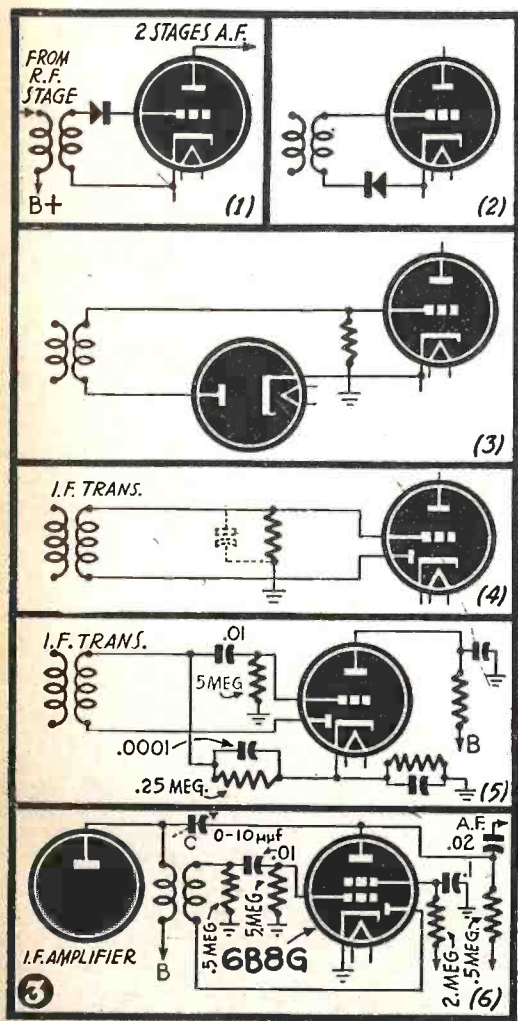
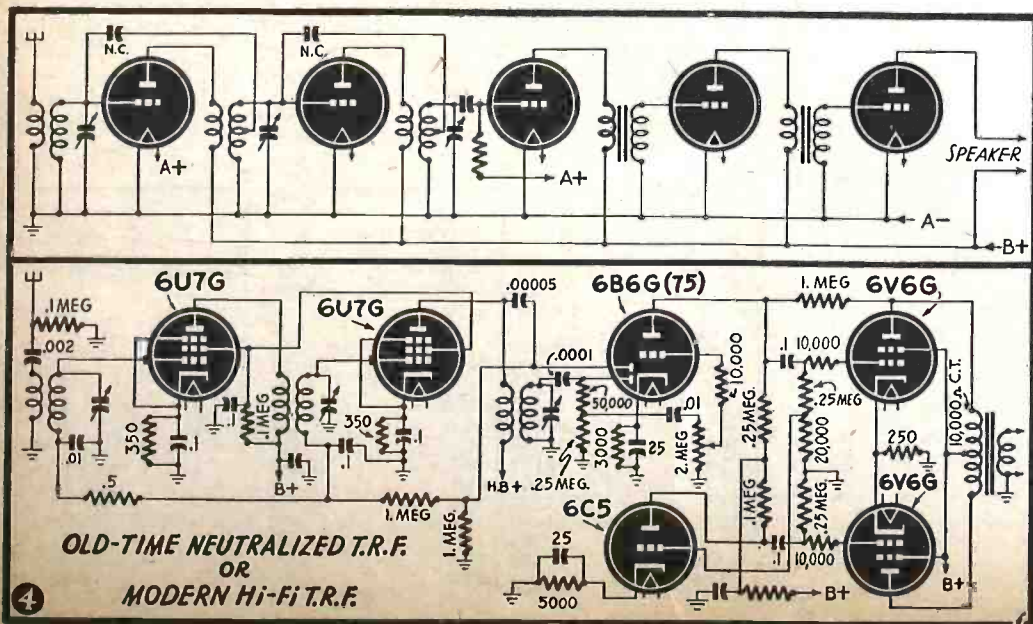
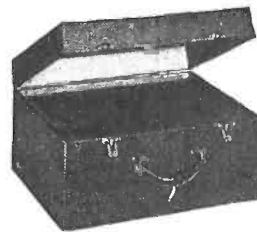

Fig. 3, left—Stages of development from the old Interflex to the modern diode detector. Fig. 4, below—Old-time and modern T. R. F.



LAKE Radio Cabinets & Parts



Portable Phonograph case, of sturdy durable plywood, in handsome brown leatherette finish. Inside dimensions 16 1/2" long, 14" wide, 9 1/2" high. Has blank motor board. As illustrated above, specially priced at **\$6.95**

Also blank table cabinets of walnut veneer in the following sizes, with speaker opening on left front side: (Note: 7* has center speaker grill.)

#1	8 1/4"	L x 5 1/2"	H x 4"	D	\$1.95
#2	10 1/4"	L x 6 3/8"	H x 5"	D	\$2.75
#3	13 1/2"	L x 7 7/8"	H x 6 1/4"	D	\$3.25
#7*	10 3/4"	L x 7"	H x 5 1/2"	D	\$2.50
#8	17"	L x 9"	H x 9 1/4"	D	\$4.50
#9	21"	L x 9 1/4"	H x 10 1/2"	D	\$5.50

*Speaker Opening in center of front side. Cabinets available in ivory color and Swedish Modern. Write for prices.

POWER TRANSFORMERS

4, 5, or 6 Tube—6.3V at 2 amp.	\$2.45
50 Mill Power Transformer	
7, 8, or 9 Tube—6.3V at 3 amp.	\$2.65
70 Mill Power Transformer	

All types of radio parts available in today's market can be obtained at Lake's money-saving prices.

Write For Our Free, New Illustrated Catalog!

LAKE RADIO SALES CO.
615 W. Randolph Street, Dept. C, Chicago 6, Ill.

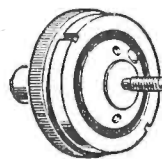

"WONDER" ELECTRIC BUTTON

Most interesting electrical apparatus ever discovered. Make your own Telephone Amplifier. Detectophone. Transmit your voice or music to distant rooms. Perform hundreds of fascinating experiments. So tiny it can be concealed in dozens of places. Send \$1 now for button and free 5,000 word instruction booklet with 50 illustrated experiments. SPECIAL OFFER 6 buttons and booklets sent postpaid for \$5. Write now to

BUCK MFG. COMPANY North Aurora, Illinois

OPPORTUNITY AD-LETS

Advertisements in this section cost 20 cents a word for each insertion. Name, address and initials must be included at the above rate. Cash should accompany all classified advertisements unless placed by an accredited advertising agency. No advertisement for less than ten words accepted. Ten percent discount six issues, twenty percent for twelve issues. Objectionable or misleading advertisements not accepted. Advertisements for August, 1945, issue must reach us not later than June 28, 1945.

Radio-Craft • 25 W. B'way • New York 7, N. Y.

BUILD RADIO COMPLETE WITH TUBES \$10.95. details. Radio, 9418b Avenue "A", Brooklyn, N. Y.

HERE'S SOMETHING! 100/1000 KC DUAL CRYSTALS with diagram for servicemen standards etc. \$12 mounted; no priority, limited quantity. Also fine commercial crystals to order, guaranteed. "Eidson's", Temple, Texas.

EMBOSSED AND PLAIN BUSINESS CARDS. SPADA, 10 Lexington, Wethersfield 9, Conn.

MAGAZINES (BACK DATED)—FOREIGN, DOMESTIC, arts, Books, booklets, subscriptions, pin-ups, etc. Catalog 10c (refunded). Cicerone's, 863 First Ave., New York 17, N. Y.

GET ON FREE MAILING LIST FOR MONTHLY TECHNICAL bulletin, "The Electronic Laboratory." IMPEDANCE LABORATORIES, Box 425C, Great Neck, N. Y.

UNIVERSAL RADIO TOOLS—DANDY 16 PIECE SET: Midget Pliers, Diagonal Cutters, Four Midget End Wrenches, Needle-nose Pliers, Screw Holder, Six Punches and Chisel, Round File, Midget Crescent Wrench, \$14.85. Remit with order. Immediate Shipment Overnight by Air to Anywhere, U.S.A. Universal Tool Company, 1527 Grand RC, Kansas City, Mo.

USED CORRESPONDENCE COURSES AND TECHNICAL Books Bought, Sold, Rented. Catalog Free. Educational Exchange, Henager, Alabama.

CORRESPONDENCE COURSES AND SELF-INSTRUCTION books, slightly used. Sold, Rented, Exchanged. All subjects. Satisfaction guaranteed. Cash paid for used courses. Complete information and 92-page illustrated bargain catalog Free. Write—NELSON COMPANY, Dept. 2-39, Chicago 4.

LARGE AND VARIED STOCK OF PANEL METERS and multi-range meters. Panel meters 3 1/2-inch round war-standard. Specify ranges you want and ask for quotation. Many D.C. instruments without priority. Good supply of critical types on priority. HATRY AND YOUNG, Hartford, Connecticut.

BOOKS FOR YOUR PERSONAL LIBRARY. SAMPLE and catalogs, 10c. ALSTONE, 426, Lunenburg, Mass.

FOR SALE: A WELL EQUIPPED AND WELL stocked radio shop. Owner drafted into service. Bowser Radio, Baxley, Ga.

MULTITESTER FOR SALE. BRAND NEW \$18.75. OR der Today. Omaha Radio Products Co., 300 Brandeis Theatre Bldg., Omaha, Nebr.

Be Your Own Boss!

START A GOOD-PAYING BUSINESS!



Stop worrying about a post-war job. Why let yourself be pushed around by economic conditions, as business slows down—when you can run your own so easily? We will show you how!

Get started at once with the aid of "CASH IN," the amazing short-cut guide to success. It contains

300 WAYS TO MAKE MONEY

It shows you how to begin—either in a small way in your own home and branch out big—or how to open a shop at once with profits rolling in immediately. It's chock full, from cover to cover, with tested money-making plans, formulas, business secrets, and sure-fire success schemes.

You can start with as little as a few dollars' capital. All you need to do is pick out the one business that appeals to you most—follow the simple directions—and then go to it!

**66 PAGES —
40,000 WORDS IN TEXT**

Send for "CASH IN" today. Enclose 25c, that's all—you won't be asked for another cent—now or later. Sold on a money-back guarantee. **25¢**

NATIONAL PLANS INSTITUTE

P. O. Box 26R, Station N, New York 23, N. Y.

YOUR NEW FREE CATALOG IS READY FOR YOU!

Radionic's Catalog No. 26 lists hard-to-get radio parts! • Helps you fill your radio and electronic needs. • All parts are available for immediate shipment • All are highest quality. • All are exceptional values.

SEND TODAY FOR YOUR FREE COPY TO Dept. 7E

RADIONIC EQUIPMENT CO.,
"CHANCELLOR" PRODUCTS
170 NASSAU STREET, NEW YORK 7, N. Y.

LEARN ELECTRICITY 12 WEEKS SHOP TRAINING



"LEARN BY DOING" IN COYNE SHOPS

Electricity offers you opportunities for the best jobs today—with a real peace time future. "Learn by Doing," on real machinery. Earn while learning. Right now I'm offering extra training in Industrial Electronics at no extra cost. Lifetime employment service after graduation. Get all-around practical training at Coyne in 12 weeks. If you are short of money I'll finance your training. Mail coupon now for Free Book. We have facilities for men with physical disabilities. If you have a physical disability of any kind check coupon below for details.

H. C. Lewis, President, **COYNE ELECTRICAL SCHOOL**, 500 S. Paulina St., Dept. 85-78, Chicago 12, Illinois. Send free book and all details. Send physical disability plan.

NAME _____
ADDRESS _____
CITY _____ ZONE _____ STATE _____



Our Headphones are used by the United States, Canadian, New Zealand and South African Governments as well as other Governments not directly in the war.

Headset

Headquarters

Scientifically Built Heavy bar magnets greatly increase their efficiency.

Folder R-7 illustrates rugged, unusually sensitive, dependable Cannon-Ball Headsets. Write

C. F. CANNON COMPANY
SPRINGWATER, N. Y.

(Continued from previous page)

be applied to the second detector of a super-het as in the sixth diagram of the series.

The feedback is obtained by condenser C which can be once set for maximum gain then left alone. The polarity of one of the coils may need reversing. This circuit is very suitable for shortwave receivers.

It is very risky to claim that anything is out-of-date in radio. The diode detector was first used about 1908, but after a brief reign disappeared from popular notice until over twenty years later, after which time it gradually recovered. It is used in most sets today. Tuning by variable inductance shows signs of returning after the war—not of

course in its original forms of variometers and tapped coils but in an efficient compact form using iron-dust cores.

In the case of the modern T.R.F. circuit shown in Fig. 4 the values given for resistors and condensers are chosen for tone and reliability. The circuit is designed to work from a high-voltage supply of from 80 to 95 milliamperes at 300 to 325 volts. Two R.F. stages are used more to give a satisfactory R.F. (and A.F.!) response curve rather than to obtain a lot of gain. Paraphase push-pull operation will be noticed. The un-bypassed bias resistor for the output tubes helps to balance the operation, resulting in cancellation of even harmonics.

A "JEWELL" OHMMETER

(Continued from page 628)

is connected in the circuit and the meter is switched to the CD circuit. The power supply voltage is adjusted to exactly 300 volts (4.5 on the meter) with the 1-megohm power supply zero adjuster. The meter is then switched to the EF circuit and the current read. (Note that zero must be adjusted for each resistor tested.)

From Ohm's law Rx can be calculated.

$$\text{Meter Reading} = \frac{300,000 \times 15}{300,000 + R_x}$$

(0 to 15 Scale)

A calibration chart showing meter readings for several values of Rx has been calculated and is shown in Table No. 3. These resistance values are 40 times those for the 7.5 volt range shown in Table No. 1.

The ohmmeter circuit is free from all errors present in the battery-operated shunt or series circuits and variations in line voltage. Internal power supply resistance and rectifier resistance are all compensated for by the zero adjustment. This circuit is easy to use and assures the greatest possible accuracy on the megohm ranges.

COMPLETE DIAGRAM AND DETAILS

All five of the individual ohmmeter circuits already discussed are combined into the schematic diagram of Figure 6 with suitable toggle switches for changing from one circuit to another.

S₁ is a D.P.D.T. toggle switch to change from the series circuit of Figure 1 to the shunt Circuit of Figure 2.

S₂ is a S.P.D.T. toggle switch to change to the Lo/10 shunt Circuit of Figure 3. S₂ shorts out the 6600-ohm resistor and places the 27.8-ohm shunt across the meter.

S₃ is a D.P.D.T. toggle switch to change the meter from a voltmeter to a milliammeter. In the check position, it is a voltmeter—see Fig. 4. In the read position, it is a milliammeter—see Figure 5—and is used in this position for making resistance readings on all ranges.

S₄ is a D.P.D.T. switch for switching from battery to A.C. operation. Note A.C. operation is possible for the medium low shunt range by setting S₄ to Power, S₁ to shunt, and S₃ to read. S₂ is set at series.

All parts are mounted on the small home-built chassis as shown in Fig. 7. The

chassis is made from a piece of fender stock to just fit into the Jewell 199 test lead compartment. It can be fastened in with a self-tapping screw through the side of the case. The transformer is mounted upside down directly under the 1 megohm potentiometer and is fastened to the top of the chassis by means of 6/32 screws which screw into two tapped 1/4" rod spacers which are soldered to the opposite ends of the transformer core shell. In soldering to steel use ammonium chloride flux to obtain a good job.

WIRING THE POWER SUPPLY

Mount all switches, jacks, and potentiometers and wire them up as much as possible. Then wire in resistor and condensers and finally mount transformer and finish wiring. The pen-light cells are mounted with a small metal strap to the end of the chassis. The toggle switches should be wired up so the toggles all point to the right when the 7.5-volt series circuit is in use.

It is best to connect the unit to the meter through one of the D.P.S.T. push-button switches on the Jewell panel. The 75 V C push button is not used when the analyzer cable is removed and the terminals to it can be disconnected, making sure that the wires are only disconnected from the push-button lugs so as not to disturb any other circuit wiring. The second lug down on either side of the push button block is the 75 V C push-button lug to use.

Remove the wires to the 4.5 V C binding posts and wire these to the push-button lugs. This brings the meter terminals out to these two binding posts, which are close to the ohmmeter unit. The meter wires from the ohmmeter unit are then fastened to these posts. The ohmmeter unit can be easily removed for battery replacement by disconnecting the wires.

When ohmmeter service is desired push and lock the 75 V C push button. This con-

TABLE No. 1		TABLE No. 2		TABLE No. 3	
Meter Reading	Rx Ohms	Meter Reading	Rx Ohms	Reading Meter	Rx
.11	1 Meg	.09	1.5	.1	40 Megs
.22	1/2 "	.30	5	.2	20 "
1.05	100,000	.58	10	.4	10 "
2.0	50,000	1.11	20	.9	5 "
2.4	40,000	1.84	35	1.4	3 "
3.0	30,000	2.50	50	2.0	2 "
4.1	20,000	4.28	100	3.5	1 "
6.4	10,000	6.67	200	5.6	500,000 ohms
9.0	5,000	8.2	300	7.5	300,000 "
11.3	2,500	9.2	400	10.0	150,000 "
12.5	1,500	10.6	600	11.3	100,000 "
13.3	1,000	11.1	700	12.9	50,000 "
14.1	500	12.0	1,000	13.9	25,000 "
14.9	50	13.4	2,000	14.5	10,000 "
15.00	0	13.8	3,000	14.8	5,000 "
		14.3	5,000		

nects the ohmmeter to the 1 mil meter. For continuity tests all switches have toggles to the right. (Be sure your switches are wired up so this will be so.) Insert test leads in the two jacks, short them, and make the zero adjustment. Then connect Rx to test leads and refer to Table No. 1 for value of Rx corresponding to meter reading.

For the medium low range shunt circuit move toggle S₁ to the left. The meter should read full scale; if not, adjust with zero adjuster. Rx can then be connected and resistance determined by reference to Table 2.

For the very low resistance range leave S₁ to left, move S₂ to left, reset zero, note reading for Rx and refer to Table 2. Divide resistance value of Rx found in Table No. 2 by 10.

For the high resistance megohm range make sure all toggles are pointing to the right. Connect Rx to test leads; plug in A.C. power-supply plug; move toggles on power switch S₁ to left, Switch S₂ to check position (left) and adjust zero adjuster so meter reads 4.5. Now switch S₃ to read position (toggle to right) and read meter. Refer to Table 3 for values of Rx corresponding to meter reading.

In case batteries are worn out and cannot be replaced, the power supply can be used for the medium low shunt range by setting the switches as follows:

S₁ to Shunt, S₂ to Series, S₃ to read, S₄ to power. Adjust zero adjuster to full scale, connect test leads to Rx and note meter reading. Refer to Table No. 2 for values of Rx. For convenience, the switch toggle positions can be shown by arrows at the bottom of each calibration chart.

This little unit is very handy to have around the shop and covers a resistance range somewhat greater than most factory jobs. It is in a number of cases more easily used as there is no changing of test leads for different ranges or for AC or DC oper-

SPEED UP REPAIRS WITH THESE G-C AIDS!



FREE STEEL CABINET

G-C DIAL BELT KITS

Exact replacement woven fabric belts. Easy to install—no stretching—no adjustments—a perfect fit everytime. Kits come with 25, 50, 100, 200 or 300 belts.

Get This New FREE Dial Belt — Drive Cable and Cabinet Repair Guide!

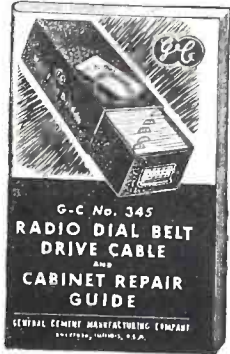

Pocket size 68 page book contains thousands of listings, specifications —time saving service instructions. Invaluable to every radio man. Get a copy from your jobber. If he cannot supply you, write us.

Immediate delivery on G-C Belts and Cables

Order From Your Radio Parts Jobber
ALWAYS ASK FOR G-C PRODUCTS



GENERAL CEMENT MFG. CO.
ROCKFORD, ILLINOIS

ation. No jumpers or patch cords are necessary as all functions are brought out to two test jacks. Furthermore there is a low and high resistance range covering all normal work which is completely powered by AC, so if battery replacements are not forthcoming the unit does not have to be put on the shelf.

The principles described above can be applied to almost any old "analyzer" now cluttering up shelf-space, thereby transforming it into an active test instrument.

Remote Control For Your Receiver

By EDWIN BOHR

HERE is a remote tuner with absolutely no wires connecting it to your radio, yet it will control volume and tuning of any set.

There is no mystery about the circuit, which is essentially an R.F. amplifier, de-

output tube. Connections are shown for connecting a microphone or phonograph into the modulator. It then becomes a phono-oscillator. Both the plate and screen-grid are modulated, which results in improved performance of the apparatus.

Some frequency should be found where there is no interfering station and the oscillator tuned to this frequency. During this process the oscillator can be modulated by touching the grid of the 6J5 while adjusting the trimmer until the

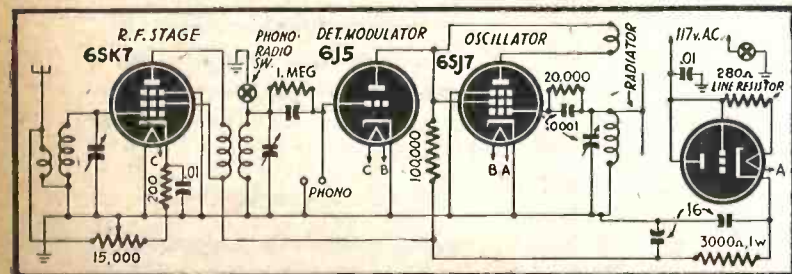

tor and modulator; and an oscillator tuned to a frequency that can be picked up by your radio. Following a signal through the tuner we can see what happens. When the tuner is tuned to the desired station the signal is amplified and detected. It is then used to modulate the fixed-frequency oscillator. If the radio is tuned to the fixed frequency the signal now radiated by the tuner is received just as from any broadcast station. Your set will receive any program sent out by the tuner.

A 6SK7 tube is used in the R.F. amplifier, a 6J5 tube in the grid-leak detector which also serves as a modulator, a 6SJ7 in the oscillator, and a 6C5 or other triode in the rectifier. A single triode may be used in the rectifier as there is no high current

grid hum is heard in the receiver. The tuning control should now be tuned to a station and the trimmer on the tuning condenser adjusted for maximum volume. This tuner will in no way interfere with ordinary operation of the receiver but if the remote tuner is to be used the radio must be tuned to the output frequency of the remote oscillator.

Uses are numerous, with only your imagination limiting possibilities for its application. It has been used with a seven tube superhet (see *Radio-Craft*, March 1944) with excellent results. There is one hitch, the fact that the selectivity depends upon the two tuned circuits in the tuner and advantages of the radio's tuned stages can't be taken.

RADOLEK

Radio-Electronic Service Parts

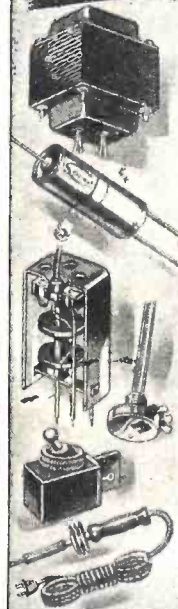

Large stocks assure the finest and most complete selections of all available items at lowest prevailing prices. Thousands of active buyers depend on us for their entire Radio repair and replacement requirements. Because we understand service problems, every order is expedited for delivery in double quick time. Everything we do is planned for convenience and satisfaction to our customers. You will find it profitable to make Radolek your buying headquarters.

FREE BUYING GUIDES

Because of existing conditions we keep our customers right up to the minute on available merchandise by releasing supplements frequently instead of sending our regular Big Profit Guide once a year. Send the coupon now to get these Free Buying Guide Supplements as they are issued.

FREE!

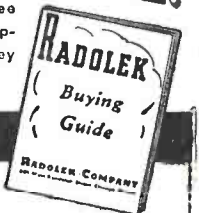

FAST SERVICE!

RADOLEK CO., Dept. C-104
601 W. Randolph St., Chicago 6, Ill.

Please send FREE Buying Guide Supplements

NAME _____
ADDRESS _____

ORDER FROM RADOLEK

Answers to Electronic Puzzle

(page 657)

23	32	20	25
28	17	33	22
31	24	26	19
18	27	21	34



**TECHNICAL
PERSONNEL
WANTED**

ELECTRONIC ENGINEERS!

War - Winners Today, Post-War Builders Tomorrow!

Leaders in NATIONAL UNION RADIO CORPORATION'S staff of engineers, scientists and technicians have brought us far out in front in the electronics industry. We have a research laboratory and two manufacturing plants in Newark, N. J., and a manufacturing plant near Philadelphia, Pa. We invite you to consider your opportunities with us for professional advancement, stimulating, friendly associations, and a future with promise.

NATIONAL UNION NEEDS:

SENIOR TUBE ENGINEERS: These men **MUST** have actual experience with radio tube manufacture. The pay and opportunities are commensurate with your ability.

COMMERCIAL ENGINEERS: Engineers interested in developing electronic tube applications, who may represent us among radio manufacturers upon occasion.

QUALITY CONTROL MEN AND WOMEN: Here you need an interest in the practical application of statistical and/or engineering procedures to many factory processes.

TEST EQUIPMENT ENGINEERS: Men experienced with meters or electronic test equipment to work either as **TEST EQUIPMENT DESIGN ENGINEERS** or as **MEASUREMENT LABORATORY ENGINEERS**.

JUNIOR ENGINEERS—MEN AND WOMEN: Do you have a college degree in Physics, Electrical Engineering, Chemical Engineering, Mechanical Engineering, Mathematics or Chemistry? This company offers an opportunity for young, ambitious graduates to assume responsibilities and to exercise initiative.

FOREMEN AND ASSISTANT FOREMEN: Men experienced in radio or radio tube manufacture to supervise exhaust, stem or grid operations.

TECHNICIANS, CIRCUIT MEN: Have you been a radio ham, or have you built or repaired radios? Have you studied radio in the Services? We need men who can read circuit diagrams and do wiring and construction.

WOMEN!

We have a number of fine young women engineers with us now. We need more. If you have a degree in Electrical Engineering, Chemical Engineering, Mechanical Engineering, Physics, Chemistry or Mathematics and are seeking career opportunities, investigate.

If you have thorough training in your field, as evidenced by job experience in radio or allied industries, or by a college degree—if you have ambition, initiative and resourcefulness—if you have the ability to inspire your co-workers, then . . .

Phone or Write

DR. L. GRANT HECTOR

Director of Engineering

NATIONAL UNION RADIO CORPORATION

Plane St. at Raymond Blvd.

Newark 2, New Jersey

WMC RULES OBSERVED

ELECTRICAL and RADIO ENGINEERS RADIO TECHNICIANS

For Design, Development and Production Work. Post-war Opportunity. Also Openings for Mechanical Draftsmen, Junior and Senior Designers.

ALLEN D. CARDWELL MFG. CORP.
81 Prospect St. Brooklyn

A one-ton electron microscope powerful enough to magnify the windpipe of a mosquito to the size of a two-inch water-pipe has been installed at the National Cancer Institute, Bethesda, Md.

BUY AN EXTRA WAR BOND

ENGINEERS WANTED

Here's an opportunity to join one of America's largest manufacturers of electronic and communications equipment.

Radio
• **Electrical**
Electronic
Industrial
(Job evaluation)
• **Mechanical**
• **Factory Planning**
Materials Handling
Manufacturing Planning

Work in connection with the manufacture of a wide variety of new and advanced types of communications equipment and special electronic products.

Write giving full qualifications, or apply to:

R. L. D., EMPLOYMENT DEPT.

Western Electric Co.

100 CENTRAL AV. KEARNY, N. J.

• Also: C. A. L.

Locust St. Haverhill, Mass.

Applicants must comply with WMC regulations

RADIO STATION TECHNICIANS

MEN AND WOMEN

for Point-to-Point International Radio-Telegraph Stations in the United States.

Applicants must possess FCC radio-telegraph commercial license, and ability to copy International Morse code at about 20 wpm.

WMC rules observed.

Apply weekdays except Saturdays between 10 am and 3 pm

or write

PERSONNEL DEPARTMENT

RCA COMMUNICATIONS, Inc.

64 BROAD STREET
NEW YORK 4, N. Y.

Civilian radios are not and have never been a subject of lend-lease, the London Board of Trade stated last month, in reply to an American report that radio sets were being shipped to Britain under Lend-Lease. The report reaching England had caused thousands of would-be purchasers to search radio stores in vain.

FIELD SERVICE ENGINEERS

For Domestic and Foreign Service and

INSTRUCTORS

Must possess good knowledge of Radio
Essential workers need release.

HAZELTINE CORPORATION

58-25 Little Neck Parkway
Little Neck, Long Island

REPAIRS WITH RESISTORS

(Continued from page 660)

of the line voltage. If it is assumed the line voltage is 115 volts, 115×0.10 gives 11.5 volts as the drop. Assuming the radios never draw more than 150 watts, which is a safe assumption if the sets are in good condition, and that the voltage is 115 volts, the maximum current is I equals P/E or $150/115$ equals 1.3 amperes. Let's assume it is 1.5 ampere to be conservative. To obtain a drop of 15 volts at 1.5 ampere would require:

$$R = \frac{E}{I} = \frac{15}{1.5} = 10 \text{ ohms}$$

The power would be:

$$P = EI = 10 \times 1.5 = 15 \text{ watts}$$

A suitable rating for the resistor would be 30 watts. Some sets would draw perhaps only .5 amp. at normal working voltage. Assuming a 5 volt drop,

$$R = \frac{E}{I} = \frac{5}{.5} = 25 \text{ ohms}$$

If the drop is 15 volts,

$$R = \frac{E}{I} = \frac{15}{.5} = 30 \text{ ohms}$$

The power would be $15 \times .5$ or 7.5 watts. In view of all this, the test resistor used for this purpose, of checking ballast resistances in series with primaries, may be rated at 30 watts and be equipped with a slider such that the resistance may be adjusted anywhere from 10 to 30 ohms.

The resistance may be adjusted until the secondary voltages of the transformer are correct. Usually it is convenient to start with high values and work lower, until the filament voltages on the amplifier tubes are correct. It is possible to use lamp bulbs but more satisfactory results are obtained using regular wirewound resistors.

The replacement of condensers and resistors may be made intelligently if fundamental principles are kept in mind, even in the face of parts shortages. The examples given merely indicated the general technique; many more could be worked out—and will be—by enterprising technical experts.

HUMAN BODY REFLECTS MICROWAVES

Professor George B. Hoadley, of the Polytechnic Institute of Brooklyn, and Chairman of the New York Section of the Institute of Radio Engineers, reports that microwaves, close relatives to wartime radar, can be reflected from the human body as well as from metal surfaces. Transmitted from an antenna one to two inches long, they exhibit strange properties. They use frequencies which are approximately two centimeters.

The radar action of microwaves was demonstrated here by Prof. Hoadley before the American Institute, by placing the transmitter and antenna equipment on the focal point of parabolic mirrors on the stage, then beaming the mirrors at a three-by-four sheet of metal held aloft at the back of the auditorium. The transmitted waves di-

rected by the parabolic reflector bounced off the metal surface and were picked up by the receiver, also in a parabolic reflector. He also showed that the waves could be reflected from a human body or even a hand placed in the path of the beam.

Using a 24-foot tube of ordinary four-inch pipe, with an elbow joint in it, Prof. Hoadley showed that microwaves can pass with undiminished power through the tubes and around bends, like water.

He demonstrated that microwaves polarize, like light, by showing that when the receiving and transmitting antennae are set at right angles to each other, no signal is transmitted, even though they are in physical contact. However, when they are parallel, the radio signal can then be transmitted.

EVER HEAR OF US???

Perhaps you haven't—because we are new in wholesale. But this doesn't mean that we don't know our business. Each man in our organization is an experienced service man. We carry only Standard Brands and all items are sold on an *Absolute Money-Back Guarantee*. Our Mail Order Dept. will bend way over backwards to please you.

CONDENSER SPECIALS

First Quality—Money-Back Guarantee

By-Pass	Buffers	Filters	
.08 ea.	.12 ea.		
.001-600v	.005-1600v	10 mfd-150v	.29
.002-600v	.007-1600v	20 mfd-150v	.34
.005-600v	.01-1600v	30 mfd-150v	.39
.01-600v	.02-1600v	50 mfd-150v	.49
.02-600v		100 mfd-50v	.39
.03-600v			
.05-600v			

600 VOLT CONDENSERS

(Sprague - Solar - Aerovox)

Mfd.		Mfd.	
.00025	.12 100	25 V.	.51
.001	.12 10	50 V.	.33
.002	.12 20	150 V.	.45
.005	.12 20-20	150 V.	.78
.01	.12 50	150 V.	.66
.02	.12 20	250 V.	.60
.05	.15 10	450 V.	.51
.1	.18 10-10	450 V.	.84
.25	.27 40	450 V.	1.05

1600 V. BUFFERS - SOLAR

.01	.27	.05	.33	.005	.27
.02	.27	.007	.27		

Resistors 1/2 Watt, 10c; 1 Watt, 12c STANDARD STOCK SIZES

Ohms	Ohms	Ohms	Ohms	Ohms	Ohms	Meg.	Meg.
0.5	30	350	2,000	8,000	25,000	0.1	1.0
1	40	400	2,250	9,000	30,000	0.125	1.5
2	50	450	2,500	10,000	35,000	0.15	2.0
3	75	500	3,000	11,000	40,000	0.2	3.0
5	100	600	3,500	12,000	50,000	0.25	4.0
7.5	120	750	4,000	12,500	60,000	0.3	5.0
10	150	800	5,000	15,000	65,000	0.4	6.0
15	200	1,000	6,000	17,500	70,000	0.5	7.0
20	250	1,250	7,000	20,000	75,000	0.6	10.0
25	300	1,500	7,500	22,500	0.75	20.0

AEROVOX

MIDGET MICA CONDENSERS
Type 1468 With Wire Leads



Midget size 29/64 x 45/64 in. provided with wire leads. Test volts 1000.

Cap. Mfd.	Price	Cap. Mfd.	Price
.000001	\$.12	.00015	\$.12
.00001	.12	.0002	.15
.000025	.12	.00025	.15
.00005	.12	.0003	.15
.00007	.12	.00035	.15
.000075	.12	.0004	.15
.0001	.12	.0005	.15
		.00075	.15
		.001	.18

SPECIAL 14c each

TRIMMER AND PADDER CONDENSERS

3-25 mmfd.	50-180 mmfd.
25-100 mmfd.	150-450 mmfd.
37-175 mmfd.	225-650 mmfd.

8 1/2 x 11" Color Code Charts
FREE on Request—With Your Order

BAKERSFIELD RADIO SUPPLY

Division of Poston Radio

2808 CHESTER AVENUE

BAKERSFIELD, CALIFORNIA

SPRAGUE Type 10-AD 10 Watts Adjustable



10-Watt
Adjustable 45c

1 3/4" x 3/8" Dia.

Catalog Type No. 10-AD

Resistance in Ohms	Current M.A.	Maximum Volts
10	1000	10
25	630	15.8
50	447	22.4
100	316	31.6
150	259	38.7
200	223	44.6
250	200	50
300	182	54.7
400	158	63.3
500	141	70.7
750	115	86.9
1000	100	100
1500	81	123
2000	70	143
2500	63	158
3000	57	174
4000	50	200
5000	44	227
7500	36	275
10000	32	316

SPECIALS

1 mfd. Generator Condensers 39c
Ford V-8 Generator Condensers 39c
Distributor Suppressors18c

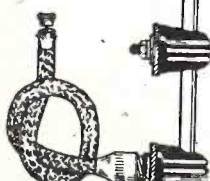

Side Cowl Aerial

ALL ORDERS MUST BE ACCOMPANIED
WITH L-265 CERTIFICATION

HARD-TO-GET PARTS METERS

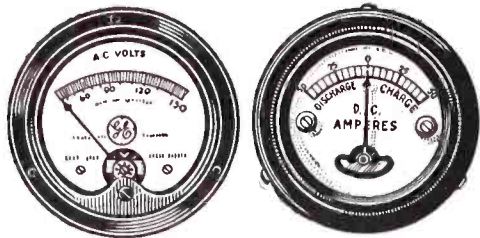

GENERAL ELECTRIC, A.C. Voltmeter, 0 to 150 Volts, type AO22, 3 1/2" flush mounting, Ship. weight 2 lbs.
ITEM NO. 163
YOUR PRICE **\$9.75**

GENERAL ELECTRIC, A.C. Ammeter, 0 to 150 Amperes, type AO22, 3 1/2" flush mounting. This is a 5-ampere A.C. meter and may be used as such with no changes. For the 150-ampere range, a current transformer is necessary. Shipping weight 2 lbs.
ITEM NO. 164
YOUR PRICE **\$8.75**

HOYT D.C. Ammeter, 50-25-0-25-50, type 531, 1 1/2" flush mounting, Shipping weight 1 lb.
ITEM NO. 165
YOUR PRICE **\$1.75**

ULTRA MAGNET

LIFTS MORE THAN 20 TIMES
ITS OWN WEIGHT

LITTLE GIANT MAGNET

Lifts 5 lbs. easily. Weighs 4 oz. Made of ALNICO new high-magnetic steel. Complete with keeper. World's most powerful magnet ever made. The experimenter and hobbyist will find hundreds of excellent uses for this high quality permanent magnet. Measures 1 3/4" x 1 1/4" Ship. Wt. 3/4 lbs.
ITEM NO. 159
YOUR PRICE **\$1.50**



GENUINE MICROPHONE TRANSMITTERS



These are regular "telephone transmitters" of the type used on wall telephones. Taken from a large telephone supply company's overstock, these fine mikes offer a grand opportunity to obtain a splendid unit for little more than the price usually asked for a simple "microphone button."

The amateur, experimenter and telephone mechanic will find a variety of uses for these excellent microphones. They work perfectly on 2 dry cells. Can be used on P.A. systems for voice transmissions, in call systems and intercommunication sets. With telephone receivers (radio headphones will do) they may be made into short-line telephone circuits, such as house-to-house or farm-to-farm "phone lines. You can use them to talk through your own radio, or as concealed dictaphone pick-up units for listening to conversations in a distant room or building. The telephone mechanic will find them useful replacements on battery-operated rural telephone lines.

THESE ARE GENUINE TRANSMITTERS, MADE BY KELLOGG, WESTERN ELECTRIC AND STROMBERG-CARLSON, excellent in appearance and operation. A remarkable value, and one seldom offered in these times. Ship. Wt. 1 lb.
ITEM NO. 160
YOUR PRICE **\$1.50**

AMAZING BLACK LIGHT!!

Powerful 250-Watt Ultra-Violet Source



The best and most practical source of ultra-violet light for general experimental and entertainment use. Makes all fluorescent substances brilliantly luminescent. No transformers of any kind needed. Fits any standard lamp socket. Made with special filter glass permitting only ultra-violet rays to come through. Brings out beautiful opalescent hues in various types of materials. Swell for amateur parties, plays, etc.; to obtain unique lighting effects. Bulb

only. Ship. Wt. 2 lbs.
ITEM NO. 87
YOUR PRICE **\$2.45**

WESTERN ELECTRIC BREAST MIKE

This is a fine light-weight aircraft carbon microphone. It weighs only 1 lb.

Mike comes with breastplate mounting and has 2-way swiveling adjustment so that it can be adjusted to any desired position. There are 2 woven straps; one goes around neck, the other around chest. Straps can be snapped on and off quickly by an ingenious arrangement.

This excellent mike can be adapted for home broadcasting or private communication systems. By dismantling breastplate, it can be used as desk mike.

Comes complete with 6-foot cord and hard rubber plug. Finished in sherdarized plate, non-rustable. Shipping weight, 2 lbs.

ITEM NO. 152
YOUR PRICE **\$2.55**

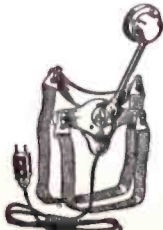

HUDSON SPECIALTIES CO.

40 West Broadway, Dept. RC-7-45, New York 7, N.Y.
I have circled below the numbers of the items I'm ordering. My full remittance of \$ (include shipping charges) is enclosed (NO C.O.D. ORDERS UNLESS ACCOMPANIED WITH A DEPOSIT.) OR my deposit of \$ is enclosed (20% required), ship order C.O.D. for balance. NO C.O.D. ORDER FOR LESS THAN \$3.00. (New U. S. stamps, check or money order accepted.)
Circle Item No. wanted: 163, 164, 165, 159, 160, 87, 152

Name

Address

Please Print Clearly

City

State

Communications

DIRECT-COUPLED AMPLIFIER PROBLEMS

(The writer of the letter below refers to the 10-watt direct-coupled amplifier described first in the July, 1939, issue of *Radio-Craft* and later in the July, 1943, Question Box. His experiences are so typical of those that servicemen have had with all types of direct-current amplifiers, ever since the days of Loftin and White, that we are printing his letter. Even the mysterious direct-coupled amplifier will yield to reason and common sense.—Editor)

Dear Editor:

Your communication dated the 5th of this month and addressed to me at Shepard, Alberta, has reached me at my new station. Many thanks for it and for the valuable enclosure of the schematic for the 10 watt D.C. amplifier.

I have checked this circuit and built it as shown. You and your readers may be interested in observations I made.

First of all, it is evident that it is useless to check voltages with the tubes out of their sockets. Not only do bias voltages, etc., disappear, but current distribution goes haywire, and the resistor network is subjected to highly erroneous voltages. If the power supply is left on, under such circumstances, several low-wattage resistors will burn up. I know—I did it!

It is not necessary to supply the filaments of the 6SJ's and 6L6's from separate transformer windings. I supplied them from the same 6.3-volt winding, and left them completely isolated from the high D.C. potentials likely to cause filament-cathode flashover by grounding them through a .5 mike paper condenser.

Two .1 mfd. condensers from each side of the primary line to ground were found

essential to kill line hash, which was the only sound audible in the speaker with the gain down. This, of course, is quite a conventional practice.

An effective gain control is a dual .5-meg. potentiometer substituted for the .5-meg. grid resistors of the 6SJ7's. No other type of volume control could be made to work properly.

The only extremely critical factors in the amplifier are (a) the emission characteristics of different 6SJ7's and (b) the values of different "100,000-ohm" plate loads for the 6SJ7's.

In my amplifier, these values were so sadly unbalanced that I started out with 2 volts bias on one 6L6 and 41 volts on the other!

Exchanging the positions of the 6SJ7's effected an immediate improvement, and the bias values changed to 7 and 19 volts. Thereafter, experimenting with a handful of different 100,000-ohm resistors finally resulted in my obtaining 16 1/2 volts bias on one 6L6 and almost 18 on the other, where I left them. Thus, the builder of this amplifier must keep a pair of 6SJ7's for it and it alone, and always place them in their correct sockets. The job would also have to be readjusted when replacing 6SJ7's. A neat simplification of this problem would be the replacement of the two 100,000-ohm resistors by a 200,000 or 250,000-ohm wire-wound potentiometer, connected across the two plates, with the variable center-tap attached to the supply voltage. Then adjustment of the biases would simply be a matter of fiddling with the potentiometer until the values were right.

FRANK GUE,
Rivers, Man.



"The selectivity on this set is so fine that if I have a soprano singing with an orchestra I can tune out the soprano!"

WORLD-WIDE STATION LIST

(Continued from page 644)

11.750	GSD	LONDON, ENGLAND; South America, 5:15 to 10:15 pm; Africa, 1 to 4 am; 5 to 11:15 am; 11:30 am to 4:30 pm.
11.765	—	ALGIERS; heard at 9:30 am and 1 pm.
11.770	KCBF	LOS ANGELES, CALIFORNIA; South America beam, 5 to 8:30 pm; 8:45 to 11:45 pm.
11.775	—	GENEVA, SWITZERLAND; 4 to 4:30 pm; 4:45 to 6 pm.
11.780	GVU	LONDON, ENGLAND.
11.780	HP5G	PANAMA CITY, PANAMA; evenings; sometimes afternoons.
11.785	FZI	BRAZZAVILLE, FRENCH WEST AFRICA; about 3 pm.
11.785	—	BELGIAN NATIONAL RADIO; heard at 6:30 to 7 pm; 9 to 9:15 pm.
11.790	WRUS	BOSTON, MASSACHUSETTS; North Africa beam, 6:30 am to 5 pm; 5:15 to 7:15 pm.
11.800	—	MOSCOW, U.S.S.R.; heard at 7:25 pm.
11.800	GWM	LONDON, ENGLAND.
11.800	JZJ	TOKYO, JAPAN; heard at 1:45 pm.
11.820	GSN	LONDON, ENGLAND; Pacific, 1:45 to 6 am.
11.826	WCRC	NEW YORK CITY; European beam, 7 to 11:15 am.
11.830	WCRC	NEW YORK CITY; Brazilian beam, 11:45 am to 12:45 pm; European beam, 1 to 5:30 pm; South America beam, 6 pm to midnight.
11.840	VLC4	MELBOURNE, AUSTRALIA; 9:45 to 10:45 pm.
11.840	—	SINGAPORE, STRAITS SETTLEMENTS; "Radio Shonan" heard at 7:30 am.
11.840	GWQ	LONDON, ENGLAND.
11.847	WGEA	SCHENECTADY, NEW YORK; European beam, 6:30 am to 4:45 pm; Brazilian beam, 5 to 11:30 pm.
11.847	XMHA	SHANGHAI, CHINA; 9 to 10 am.
11.850	CEI185	SANTIAGO, CHILE; heard at 1:30 am.
11.855	—	HAVANA, CUBA; evenings.
11.860	GSE	LONDON, ENGLAND; Africa, 11:15 am to 2:45 pm; South America, 4 to 10:15 pm; Mediterranean, 5 am to 3:45 pm.
11.870	WNBI	NEW YORK CITY; South America beam, 7:30 pm to midnight.
11.870	WOOW	NEW YORK CITY; European beam, 6:30 am to 5:15 pm; 5:30 to 6:45 pm.
11.870	KWIX	SAN FRANCISCO, CALIFORNIA; New Guinea beam, 4:15 to 5:45 pm.
11.880	VLR3	MELBOURNE, AUSTRALIA; 9:45 pm to 3:45 am.
11.880	LRR	ROSARIO, ARGENTINA; heard at 8:30 pm.
11.885	—	MOSCOW, U.S.S.R.; 6:45 to 7:25 pm.
11.890	KNBA	SAN FRANCISCO, CALIFORNIA; East Indies beam, 11:30 pm to 4:45 am.
11.890	KNBX	SAN FRANCISCO, CALIFORNIA; South America beam, 7 to 9:30 pm; 9:45 to 11:05 pm.
11.893	WRCA	NEW YORK CITY; Brazilian beam, 6:45 to 7:15 am; European beam, 1:15 to 4:45 pm.
11.897	JVU3	TOKYO, JAPAN; 6:15 to 8:15 pm.
11.900	XGOY	CHUNGKING, CHINA; Allied Forces in the Far East, 8 to 9 pm; Asia, Australia, New Zealand beam, 6 to 6:30 am; East Russia beam, 6:30 to 7 am; Japan beam, 7 to 7:30 am.
11.900	CXA10	MONTEVIDEO, URUGUAY; heard at 8:15 pm.
11.930	GVX	LONDON, ENGLAND; North America, 6:15 to 8 am; 2:30 to 5:15 pm; Pacific, midnight to 4 am; India, 10:30 am to 12:30 pm.
11.940	—	MOSCOW, U.S.S.R.; 8:10 to 8:50 pm.
11.950	—	MEXICO CITY, MEXICO; heard evenings.
11.955	GYV	LONDON, ENGLAND.
11.970	FZI	BRAZZAVILLE, FRENCH WEST AFRICA; noon to 8:50 pm; 1 to 2:30 am.
11.995	CSW	LISBON, PORTUGAL; heard about 8:30 am.

A new record for round-the-world radio transmission was established by the U. S. Army Signal Corps on April 28, when it sent a nine-word radio-teletypewriter message completely around the earth in 9½ seconds.

In a test to demonstrate the flexibility of Army Communications Service's world-girdling system, the message was transmitted from Washington through automatic relay stations at San Francisco, Manila, New Delhi and Admara, then back to Washington. Regenerative repeaters were used at the relay points.

The transmission was almost instantaneous. Exactly one second after the perforated tape containing the message began moving through a teletypewriter transmitter, a nearby receiving machine started printing the message at the end of its round-the-world journey. The one second represented the time lag in the electrical transmission, the other 8½ seconds being the time mechanically required to send the message.

TOUGH!

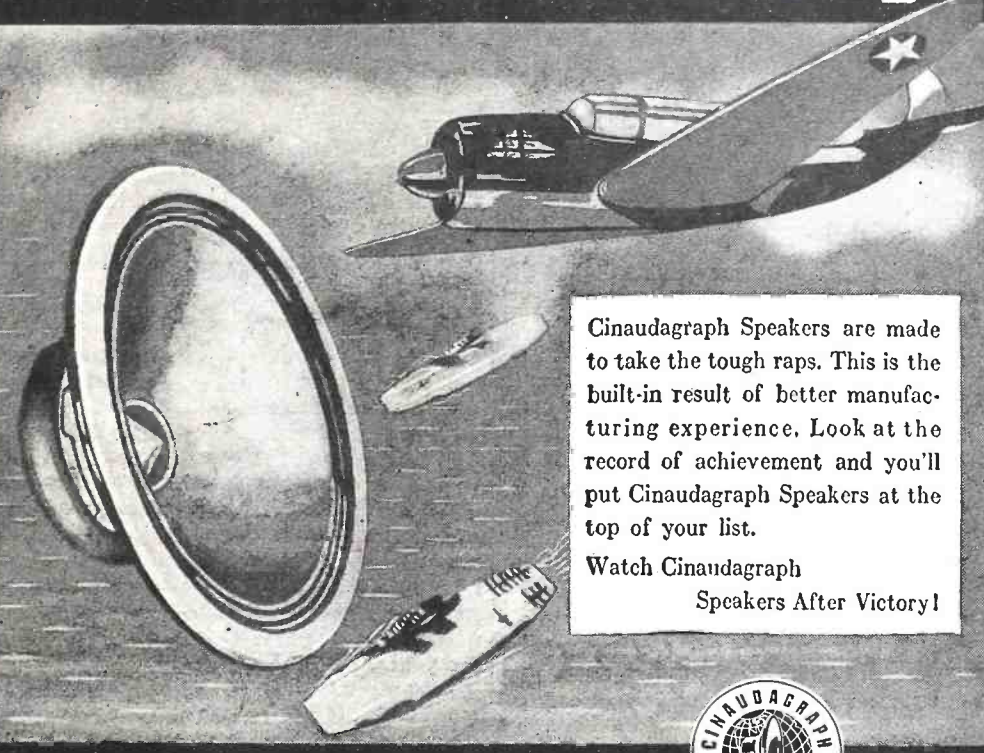

Cinaudagraph Speakers are made to take the tough raps. This is the built-in result of better manufacturing experience. Look at the record of achievement and you'll put Cinaudagraph Speakers at the top of your list.

Watch Cinaudagraph Speakers After Victory!



Cinaudagraph Speakers, Inc.

3911 S. Michigan Ave., Chicago
Export Div., 13 E. 40th St., New York 16, N. Y.

"No Finer Speaker in all the World"

Be the ELECTRICIAN

who "Knows the answers!"

GET THESE 2 GREAT BOOKS NOW

Knowledge means bigger pay in Electricity and Radio. Solve problems quickly, easily with these COYNE books. See them 7 DAYS FREE before you decide. Coupon is not an order—just a request to examine either or both books at my risk.

Electricians Handbook

Fits the Pocket, 4½" x 7" — 5,000 Facts

Latest wiring methods, motors, code rules, charts. Includes Electronics. Not a textbook but a practical helper that belongs in your kit. Must be seen to be appreciated. Just off the press. Red leatherette cover, \$2.75 cash.

Trouble Shooting Manual

GIANT SIZE—4 BOOKS IN ONE
How to locate, repair troubles on Electrical machinery, radios, appliances, refrigerators, auto elec., etc. 500 easy-to-follow diagrams. Complete Trouble Shooting Course. A gold-mine of money-making help. 612 p., 8½ x 11¼, leatherette cover. \$8 cash, \$8.95 on easy terms.

SEE BOOKS 7 DAYS FREE!

H. C. Lewis, President, COYNE ELECTRICAL SCHOOL
500 S. Paulina St., Dept. 85-T1, Chicago 12, Illinois

Send either or both books checked below for 7 days FREE examination. In 7 days I'll either return them or pay according to the plan I select as outlined below.

COYNE TROUBLE SHOOTING MANUAL, 1 vol. 612 pages, \$8.00 cash or \$3 after 7 days and \$3 per month until \$8.95 is paid.

COYNE ELECTRICIANS HANDBOOK, 1 vol. 400 pages, \$2.75 after 7 days trial.

Special Payment Plan
 Check here if you want both books. If you decide to keep them you can send \$3 after 7 days trial and \$3 per month until \$11.70 is paid or you can pay \$10.75 cash and save 95 cents.

NAME.....AGE.....
ADDRESS.....
FIRM EMPLOYED BY.....
 If you want one or both books sent C.O.D. (you pay postman cash price shown) check here. Same 7 days trial and money back guarantee.

IMPROVED SUPER DRILL GRINDER

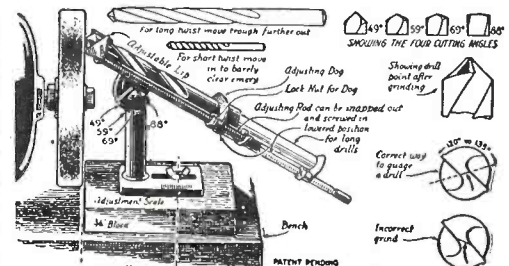

ONLY \$2.95 COMPLETE!

Model No. 2 grinds round shank drill points from No. 42 to 1 1/16" diameter. Grinds old drills like new. Grinds short, medium and long twist drills up to 11". The grinder that gives a rounded point.

Money Back Guarantee!

GRIND YOUR DRILLS LIKE FACTORY IN 25 SECONDS! Get a perfect center and clearance in four different point angles—49°—59°—69°—and 88°. No machine shop or work shop should be without the super drill grinder. A post-war product now!

Ask your dealer to supply—if he cannot serve you, mail your check or money order for only \$2.95, with your printed address—the SUPER GRINDER will come to you by return mail, postage paid.

The Ideal Tool for the Hobbyist!
AVAILABLE NOW—BUY IT TODAY

A. D. MCBURNEY

939 WEST 6TH STREET DEPT. RC-7
LOS ANGELES 14, CALIFORNIA

FCC Chairman Porter sees no relaxation of "freeze" policies on station construction until Japan is beaten. Continuing military needs will also prevent quantity production of home receivers until 1946, according to WPB, although some varieties of sets may reach the market by Christmas.

★ ★ ★ ★ ★ ★ ★ ★
BUY AN EXTRA WAR BOND
★ ★ ★ ★ ★ ★ ★ ★

THE ANSWERS

1700

ANSWERS

TO YOUR HARDEST PROBLEMS



1178 Illustrations
1000 Pages

130 Tables — 105 Graphs

GET THE ANSWERS NOW!

Here, in one big volume, you'll find all the time saving answers to your radio problems... and time saved is **MONEY EARNED**. Written in easily understood language, yet accurate enough for an engineer. Completely revised and cross indexed for quick reference, this handy reference book for your tough jobs covers radio transmission and reception, public address systems, television, photocells and data on their important parts. It's a book you'll always use. And... it's only **\$5.00**

ANOTHER TIME SAVING BOOK!

ELECTRICAL AND RADIO DICTIONARY. Over 3800 definitions of technical words and terms used in all branches of radio and electricity. 800 Pages—650 Illustrations..... **\$2.50**

GATEWAY PUBLISHING COMPANY

53 W. Jackson—Dept. RC-7
Chicago 4, Ill.

Clip This Coupon NOW

- Send me the new Drake Cyclopedic IMMEDIATELY.
- And the 300 Page Radio Dictionary.

Name

Address

City State

LEARN RADIO EASIER... FASTER
"THE MYSTERY OF RADIO"

NOW READY

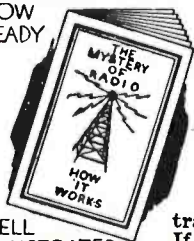

simplifies training procedure, by outlining T-R-F and superheterodyne principles.

EXPLAINS the net work of circuits (One at a time) of an AC-DC five tube superheterodyne system.

ORDER this practical training aid without risk. If not fully satisfied, return within 3 days for refund.

WELL ILLUSTRATED

Only \$1 Postpaid.

Send money order, bill or check.

SCIENTIFIC RADIO SERVICE SYSTEM
Sioux City, Iowa Box 1285-C

PATENTS—TRADE MARKS

Booklet concerning Inventions & Patents Form "Evidence of Conception" with instructions for use and "Schedule of Government and Attorneys Fees"—Free

LANCASTER, ALLWINE & ROMMEL
Registered Patent Attorneys

486 Bowen Bldg. Washington 5, D. C.

Do you need BINDING POSTS?



The **XL PUSH POST** with its Spring Action assures Constant Contact and quick connection.

Manufactured in All Aluminum Type M at 12c each.

Aluminum Body, Bakelite Top Type B1 at 15c each.

Types CP or NP. ALL BRASS—STAINLESS STEEL SPRING & PIN. PROVEN by 240 HR. SALT SPRAY TEST as NON-CORROSIVE at 28c each.

Manufacturers and Dealers Liberal Discounts

X. L. RADIO LABORATORIES

420 West Chicago Ave., Chicago 10, Ill.

RADIO CAN ENFORCE PEACE

(Continued from page 621)

only save untold lives of future generations, who might have to go to war, but untold billions in treasure as well.

Now then, if the United States has been willing to lend-lease astronomical amounts of matériel and services for war purposes, it certainly should be willing to lend-lease other matériel and services in comparative modest amounts for the enforcement of peace. If the United States becomes convinced that if within one or two generations all the nations will understand and speak English for a better world understanding, then America will be prepared to pay the cost for rendering this service to humanity.

Here is how it can be done; and again I emphasize that only the United States of America—due to its commanding position—will be the one country to do it.

Let the United States tell the nations of the world that it stands ready to lend-lease to them radio sets for a certain percentage of their inhabitants. A study would be made to ascertain how many radios could be required by each country, and a program would be started to lend-lease its full quota over a period of between four and six years.

As an example, the Latin American radio market is about 700,000 radios, according to S. J. Roll, foreign trade counsel of the Pan-American Airways System. That is not the whole story because other nations are also supplying their share to the Latin American market now and it is quite possible that two million radio sets a year for a number of years to come, would not saturate the Latin American homes with radio facilities.

Every modern country is, for obvious reasons, most anxious to have as many homes as possible equipped with radio sets. The government which can talk to the largest audience of its own nationals will accomplish more than the nation which is not completely radio equipped. That today is an elementary truth.

If now the United States is ready to lend-lease a huge number of radio sets to every country in the world, it will also expect something in return. What will America get in return for its billions of investment in such radio sets? The answer is: first a treaty by which each nation pledges herself to teach English in her schools, with the same effort as the present national language is taught. The United States is not giving away its radio sets, but it only lends them. If a country does not comply in fact and in spirit with this treaty obligation then the United States Government will have a right to repossess the radio sets lend-leased to that country.

In the treaty the country also obligates itself that broadcasts originating from the United States, or through foreign stations, working in conjunction with the United States, will at no time be excluded, interfered with or banned to its nationals, whether on regular waves or short waves.

The United States will have the right to maintain relay stations in various parts of the world to disseminate radio broadcasts wherever it deems wisest to acquaint the various nations with American programs, which are to be always in the English language. Most nations probably would not have any objection to such an arrangement, more so as they already know that the United States has no ulterior political motive behind such broadcasts, except to

(Continued on page 676)

Index to advertisers

Aerovox Corp.....	658
Allen Manufacturing Co.....	662
Allied Radio Corp.....	664
Amperite Co.....	657
Amplifier Co. of America.....	666
Audel & Co., Theo.....	678
Bakersfield Radio Supply.....	671
Buck Manufacturing Co.....	667
Buffalo Radio Supply.....	660
Burgess Battery Co.....	653
Burstein-Applebee Co.....	666
Cannon Co., C. F.....	668
Capitol Radio Eng. Institute.....	656
Cardwell Mfg. Corp., Allen D.....	670
Cinaudagraph Speakers, Inc.....	673
Concord Radio Corporation.....	649
Coyne Electrical School.....	653, 668, 673
Crandall Mfg. Co.....	673
DeForest's Training, Inc.....	617
Electronic Winding Co.....	647
Gateway Publishing Co.....	674
General Cement Mfg. Co.....	669
General Electric Co.....	657
Hallicrafters Co., Inc.....	615
Hazeltine Corporation.....	671
Henry Radio Shops.....	659
Hudson Specialties Co.....	672
International Detrola Corp.....	Back Cover
Lake Radio Sales Co.....	667
Lancaster Allwine & Rommel.....	674
Lifetime Sound Equipment Co.....	663
McBurney, A. D.....	673
McElroy, T. R.....	660
McGraw-Hill Book Co.....	675
Maedel Publishing House.....	675
Mallory & Co., Inc., P. R.....	677
McMurdo Silver Corp.....	655
Meissner Mfg. Co.....	616
National Plans.....	668
National Radio Institute.....	611
National Schools.....	619
National Union Radio Corp.....	612, 670
Onan & Sons, D. W.....	663
Opportunity Adlets.....	667
Personnel Help Wanted.....	670, 671

RADIO SCHOOL DIRECTORY

Page 676

American Radio Institute	
Candler System	
Capitol Radio Engineering Institute	
Commercial Radio Institute	
Lincoln Engineering School	
Melville Radio School	
RCA Institute	
<hr/>	
RCA Communications.....	670
Radio & Television Supply Co.....	660
Radio Electric Service.....	659
Radio & Technical Division	
Murray Hill Book Co.....	640, 641
Radio Wire Television, Inc.....	652
Radionic Equipment Co.....	668
Radolek Company.....	669
Raytheon Manufacturing Co.	
Inside Back Cover	
Scientific Radio Service.....	674
Solar Capacitor Sales Corp.	
Inside Front Cover	
Sprague Products Co.....	620, 639
Sprayberry Academy of Radio.....	613
Supreme Instruments Corp.....	654
Supreme Publications.....	661
Sylvania Electric Co.....	643
Triplett Elec. Instrument Co.....	618
Ungar Electric Tools, Inc.....	665
Western Electric Co.....	670
Wholesale Radio Laboratories.....	651
X-L Radio Labs.....	674

Available Radio-Electronic Literature

Manufacturers' bulletins, catalogs and periodicals.

A NEW SERVICE FOR RADIO-CRAFT READERS: In order to save your time, postage and incidental work in writing a number of letters to different manufacturers to secure the various bulletins offered, proceed as follows:

On your letterhead (do not use postcards) ask us to send you the literature which you designate. It is only necessary to give us the numbers. We will then send your request directly to the manufacturers, who in turn will send their bulletins or other literature directly to you.

142—CATALOG, issued by General Electronics, Inc., describing the complete line of electron tubes now being manufactured for military, broadcast, industrial heating, medical and short wave use. Each tube is described on a separate page, with its ratings, socket connections and typical operational data.

143—25 YEARS OF PROGRESS WITH RCA.

A review of advances in radio. An 87-page book describing the parallel progress of the radio art and the Radio Corporation of America from its founding to the present day.

Beginning with the origins of the company in 1919, it traces broadcasting from the idea of a "radio music box" already suggested by David Sarnoff in 1916 through the vast expansion in the '20's, the formation of the National Broadcasting Company in 1926, and on to the present day. The part played by Radiomarine Corporation and RCA Communications is then told, and the building of Radio City described.

Television now takes a leading place, followed by FM, and the conversion of RCA's facilities to the service of the country with the outbreak of war. The work of the RCA Laboratories is evaluated and the electron microscope presented. The book also contains a double-page color map of the RCA communication system throughout the world.—*Gratis to interested parties.*

144—MASTS AND TOWERS.

Harco Towers are listed and described. Structures for various conditions and wind velocities are diagrammed and characteristics given. Heights are from 20 to 500 feet.—*Gratis*

145—INSULATING MATERIALS.

A complete catalog on Electrical insulating materials and their properties. Each type of material and product is listed in its own section in a simple, informative manner so that selection for various applications may be made. Proper handling and machining methods are included.

This 85-page catalog is published by the Mica Insulator Co. for interested business concerns requesting it on their stationery.

146—INSULATION RESISTANCE.

An 8-page catalog by Leeds & Northrup describing two test set assemblies for accurate measurements. One assembly is suitable for routine plant tests, the other for high sensitivity laboratory measurements.—*Gratis*

147—FM FOR EDUCATION

A bulletin by the U.S. Office of Education to encourage the use of FM facilities by schools and colleges. Costs of erecting and maintaining FM stations are discussed and typical installations listed. FM's advantages and limitations are shown. Also contains suggested uses for FM in the field of school sports, public relations, adult education and student technical training.—*Gratis*

148—COAXIAL CABLE.

Interesting data on coaxial cables and accessories by the Victor J. Andrew Co., listed as their Bulletin 23. Characteristics of lines are tabulated. Also includes a description of a direct reading phase monitor and a remote indicating antenna ammeter. It concludes with reprints of short articles on phase monitors and transmission lines.—*Gratis*

149—INSTRUMENT TRANSFORMERS.

This handy guide by G.E. is useful for those requiring potential or current transformers. Part I explains transformer standards and definitions in 16 pages. Tables and graphs are provided for this purpose. Part 2, 36 pages long, lists the complete G.E. line with photos and description.—*Gratis to interested parties*

150—COMMERCIAL TRANSFORMERS.

These booklets by Federal Telephone & Radio Corp. supply full description and photographs of complete transmitting equipment. Four separate booklets are available: (a) 5 K.W. transmitter, (b) FTR-3 transmitter, (c) 20 K.W. high frequency transmitter, (d) Marine unit transmitter.—*Gratis*

151—INERTEEN CAPACITORS.

An 11-page booklet by Westinghouse with information for the plant which is operating at low power factor. It is shown how the addition of capacitors permits the use of a greater load without damage to existing lead cables. Actual cases are cited and resulting improvement listed. A graph indicates required capacitor for a desired power factor correction.—*Gratis*

152—VARIABLE CAPACITORS.

This is a photographic and descriptive story of the Hammarlund variable condenser. The product is followed through its several stages to completion. Special types designed for particular service are shown, and the advantages possessed by the post-war condenser can be readily appreciated.—*Gratis*



Suggested by: E. F. Gault, Ottawa, Ont., Canada

"He used to be a radio experimenter."

NOW—A REALLY HIGH-POWERED— Radio Engineering Library

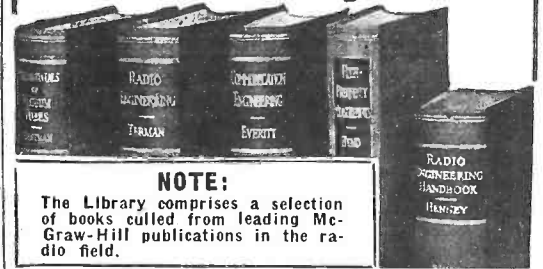

NOTE:

The Library comprises a selection of books culled from leading McGraw-Hill publications in the radio field.

- especially selected by radio specialists of McGraw-Hill publications
- to give most complete, dependable coverage of facts needed by all whose fields are grounded on radio fundamentals
- available at a special price and terms

THESE books cover circuit phenomena, tube theory, networks, measurements, and other subjects—give specialized treatments of all fields of practical design and application. They are books of recognized position in the literature—books you will refer to and be referred to often. If you are a practical designer, researcher or engineer in any field based on radio, you want these books for the help they give in hundreds of problems throughout the whole field of radio engineering.

5 VOLUMES, 3319 PAGES, 2289 ILLUSTRATIONS

1. Eastman's FUNDAMENTALS OF VACUUM TUBES
2. Terman's RADIO ENGINEERING
3. Everitt's COMMUNICATION ENGINEERING
4. Hund's HIGH FREQUENCY MEASUREMENTS
5. Henney's RADIO ENGINEERING HANDBOOK

10 days' examination. Easy terms. Special price under this offer less than books bought separately. Add these standard works to your library now; pay small monthly installments, while you use the books.

10 DAYS' FREE EXAMINATION—SEND COUPON

McGraw-Hill Book Co., 330 W. 42nd St. New York 18

Send me Radio Engineering Library, 5 vols., for 10 days' examination on approval. In 10 days I will send \$3.00, plus few cents postage, and \$3.00 monthly till \$24.00 is paid, or return books postpaid. (We pay postage on orders accompanied by remittance of first installment.)

Name

Address

City and State

Position

Company RC 7-45

MATHEMATICS FOR RADIO

Two volumes, prepared for home study. Book I (314 pp.) covers the algebra, arithmetic, and geometry; Book II (329 pp.) covers the advanced algebra, trigonometry, and complex numbers necessary to read technical books and articles on radio.

MAEDEL PUBLISHING HOUSE Room 117
593 East 38 Street, Brooklyn, New York

Send me MATHEMATICS FOR RADIO AND COMMUNICATION as checked below. I enclose payment therefor with the understanding that I may return the book(s) within 5 days in good condition and my money will be refunded.

Name

Address

- Book I at \$3.75 plus 6c postage
- Book II at \$4.00 plus 6c postage
- Books I and II at \$7.75 postage prepaid

Foreign and Canadian prices 25c per volume higher

RADIO SCHOOL DIRECTORY

PREPARE NOW FOR POST-WAR RADIO AND ELECTRONICS

MAKE a place for yourself in a new world of radio and electronics—a world in which revolutionary electronic developments will require highly specialized technical knowledge. Take a good course now to fit yourself for a good paying job. The training you need can be supplied by one of the schools advertised in this publication.



RADIO

Train with professionals. Complete, intensified courses: Repair & Maintenance, Communications, High-speed telegraphy, Slip transcription, FCC exams, etc.

High School Students accepted for training as Merchant Marine Radio Officers.

Gov't sponsorship available to veterans.

"A Radio School managed by radio men."
45 W. 45th St., Dept. RC, New York 19, N.Y.

MELVILLE RADIO INSTITUTE

COMMERCIAL RADIO INSTITUTE

A radio training center for twenty-four years.

RESIDENT COURSES ONLY

Pre-Induction, Broadcast, Service, Aeronautical, Television and Marine telegraphy classes now forming for October 1. Literature upon request. Veteran training.

Home Study Course In Mathematics

Dept. C., 38 West Biddle St., Baltimore 1, Md.

RADIO

RADIO Technician and Radio Communications courses. Register now for new classes starting first MONDAY of each month. Day and Evening Classes.

AMERICAN RADIO INSTITUTE

101 West 63rd St., New York 23, N. Y.
APPROVED UNDER GI BILL OF RIGHTS.



INSTITUTES

Offer thorough training courses in all technical phases of

Radio and Television

DAYS—EVENINGS WEEKLY RATES

VETERANS: RCA Institutes is approved under G. I. Bill of Rights

For Free Catalog Write Dept. RC-45

RCA INSTITUTES, Inc.

A Radio Corporation of America Service
75 VARICK STREET NEW YORK 13, N. Y.



SHORT CUT



CODE SPEED

Be an Expert

Learn to be a Telegraph or Radio Operator. Thousands of men needed. Intensely interesting work—good pay. Learn at home or wherever you are, quickly, easily, with the famous Candler Code Speed System. Book of particulars Free.

Candler System Co., Dept. 3H, Box 928, Denver 1, Colo.

Correspondence Courses in

RADIO and ELECTRICAL ENGINEERING

ELECTRICAL ENGINEERING Get good grasp of wide electrical field. Prepare yourself, at Low Cost, for secure future. Modern, simplified, you can understand quickly.

RADIO ENGINEERING Extra fine course in radio, public address, photo-electric work. Train you to be super-service man, real vacuum tube technician. Servicemen needed badly. Diploma on completion. Tuition \$25, either course. Deferred payment plan.

FREE Get copies of school catalogs, student magazines, complete details. SEND NOW!

LINCOLN ENGINEERING SCHOOL Box 931C-77, Lincoln, Nebr.

RADIO-TELEVISION

ENGINEERING & SERVICING

New Training Veterans Under "G.I." Bill Prepare now for profitable career! ENTER AT ANY TIME. Residence school classes in Radio-Electronics Engineering, Broadcast & Television Engineering and Servicing. Write for FREE Booklet.

Capitol Radio Engineering Institute
Dept. RC-7, 3224 16th Street, N. W., Washington 10, D. C.

See Big Ad. Page 656

RADIO CAN PREVENT WAR

IN conjunction with the above article we give herewith a few excerpts from statements on the use of radio to help prevent future wars. The statements were made by leading delegates at the San Francisco Convention in a preliminary report on a survey made by the British Broadcasting Corporation.

Jan Masaryk, leader of the Czechoslovakian delegation: "I cannot think of a successful functioning of the international security organization without the closest possible contact among nations through the medium of radio. It seems to me that international cooperation in the field of communication is one of the next important steps to be taken up jointly by all nations of the world in order to make the charter of peace effective. Radio helped us to win the war in Europe. It can help us even more in our task of preserving peace."

M. Bidault, France's minister of foreign affairs: "We, the French people, who for so long have lived under the worst enemy domination, are grateful to the BBC for giving us the daily information needed to foster our hope. Every night, those among us who had managed to keep their wireless sets, would listen in to the London broadcasts. In those days I have already expressed the very special gratitude the whole French nation felt for the BBC. Today in San Francisco I am happy to repeat openly what our secret messages then tried to convey. . . . Who can deny that broadcasting will not be less necessary for peace than it proved for victory? Men and women today turn their eyes in expectation toward those who have microphones at their disposal. We trust that the radio, and especially the British radio, will remain faithful to the principles upon which it worked at the time of our trials."

China's delegation: "The importance of radio broadcasting in wartime has been amply demonstrated during the last few years. The greater importance of the role of radio after the war is becoming universally recognized. In the closely knit world of tomorrow international broadcasting can be one of the effective forms of education and cultural cooperation among the nations. . . ."

Bitwodded Makonnen Endalkachau, prime minister of Ethiopia, "It is particularly important that their viewpoints and problems be understood and appreciated abroad. It is doubtful whether any single instrument is more clearly capable of laying the foundations of mutual comprehension among the peoples of the world than is radio. Its world-wide development in the postwar years is a matter of imperative necessity."

Faris El-Khour, prime minister of Syria: "Radio must have as its aim for the postwar period the focusing of thoughts on the problems of lasting peace. This could be attained by studying and honestly presenting to the peoples of the world the real facts and the different points of view of the countries concerned."

Francis M. Forde, deputy prime minister of Australia: "Radio will prove potent in preventing another war. Improvements made in short wave broadcasting during the war years will, I think, be proved a weapon that can be used in the battle for permanent peace. To the people on whom fall the responsibility of operating the world's radio networks falls a great responsibility . . . to misuse it would be a major crime. If it is used as it should be used, it will prevent the major crime of war."

Program distribution systems for installation in all General Hospitals in continental United States have been developed by the Signal Corps.

Thirty-six of the Army's sixty-five General Hospitals will have received complete installations by the end of 1945.

The standard radio program distribution system consists of a central control console and necessary amplifier equipment to provide four simultaneous program channels, being so arranged that any type of program except television may be received and re-broadcast. Special additional provision has been made for pickup of bedside interviews for rebroadcast or for "live" shows which may originate in any part of the hospital.

Each bed patient may choose one of four programs by the pull of a string attached to a bed unit which may be placed under the pillow or hung at the head of the bed or placed near his ear.

RADIO CAN ENFORCE PEACE

(Continued from page 674)

acquaint other nationals with international news and particularly the spirit and ideas of the democratic world.

It is felt that by means of such an arrangement, if it is successfully pushed to its conclusion, it will be possible for most of the world in somewhat less than two generations to read, write and understand English, which then will be the first stepping stone toward a permanent peace.

That many other advantages will accrue to the United States from such an arrangement is quite apparent and I do not think it is necessary in a short article to go into all the various phases and ramifications.

As a postwar project this plan will be of tremendous importance to the American radio industry—the one radio industry in the world able to produce the fantastic amount of radio sets needed for such a program.

There would be required probably a minimum of fifty million radio sets a year over a term of some years to come, until every home throughout the world was radio equipped. Remember that in the United States today there are over thirty million radio sets and that under the present war output conditions the entire American radio industry probably would be able to turn out somewhere between thirty and fifty million radio sets a year. There is a possibility that the present radio set manufacturing industry would have to expand in

order to meet this program, but it is possible to realize it. The radios to be furnished on this lend-lease plan would not be elaborate, but would in all probability be a specified type of table model, adaptable for the various countries. The sets would have to be equipped for long, medium, and short waves according to requirements. Probably not more than six models would be made to take care of the various conditions of the foreign countries. The amount of money that the United States would have to expend would be between half a billion and one billion dollars a year, for the duration of the projected program.

It is conceivable that some of the other major countries might voice some objections to such a program because they might figure that they are being deprived of their foreign radio set markets. The answer to this is that if other nations also wish to lend-lease radio sets to foreign states the United States would have no objection to this. It is believed that such objections could be overcome without much friction. It certainly would cause no more friction than any number of the present international problems, questions and sore points which still are awaiting solution.

America has led the world in many different ways. Let it now lead the world through a better mutual understanding to a lasting peace—via Radio.



FIRST in Research
FIRST in Development
FIRST in the Shops of
Service Engineers

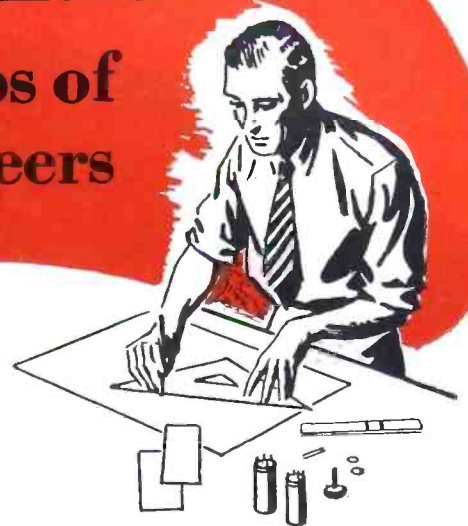

Pioneering by MALLORY Has Resulted in These History-Making Developments:

1. High voltage dry electrolytic capacitors.
2. Dry electrolytic capacitors in cardboard containers.
3. Etched plate A.C. capacitors.
4. Dry electrolytic capacitors for operation at temperatures as high as + 85 degrees centigrade.
5. Toroidal type A.C. capacitors.
6. High surge characteristics of dry electrolytic capacitors by employing cellophane separators.
7. F.P. (fabricated plate) capacitors.
8. Capacitors with self-mounting features.
9. Multiple dry electrolytic capacitors with controlled coupling characteristics.
10. Complete information for determining physical size of dry electrolytic capacitors of given rating.
11. Completely standard dry electrolytic filter capacitors.
12. Standard, close capacity tolerances on A.C. capacitors.
13. A standard line of A.C. capacitors in plastic containers.
14. Dry electrolytic capacitors with satisfactory performance at temperatures as low as -40 degrees centigrade.

These are a few of the many reasons why Mallory dry electrolytic capacitors have a deserved reputation for quality—why millions are in service today. Moreover, the Mallory line of capacitors is *complete*, and its distributors are ready to help solve your problems. Avail yourself of this service—begin today by asking for a copy of the Mallory Catalog of Approved Precision Products.

P. R. MALLORY & CO., Inc., INDIANAPOLIS 6, INDIANA



More than ever—
 ALWAYS
 INSIST ON

P. R. MALLORY & CO. Inc.

MALLORY

APPROVED
PRECISION PRODUCTS

VIBRATORS • VIBRAPACKS* • CONDENSERS
 VOLUME CONTROLS • SWITCHES • RESISTORS
 FILTERS • RECTIFIERS • POWER SUPPLIES

ALSO MALLORY "TROPICAL" DRY BATTERIES, ORIGINALLY DEVELOPED BY MALLORY FOR THE U. S. ARMY SIGNAL CORPS, NOT PRESENTLY AVAILABLE FOR CIVILIAN USE.

*Trademarks

**NEW EDITION
NOW READY**

Audels RADIOMANS GUIDE

Includes **TELEVISION
AND ELECTRONICS**

LARGER - MORE COMPLETE - 914 PAGES - 633 ILLUSTRATIONS - WIRING DIAGRAMS - PHOTOS

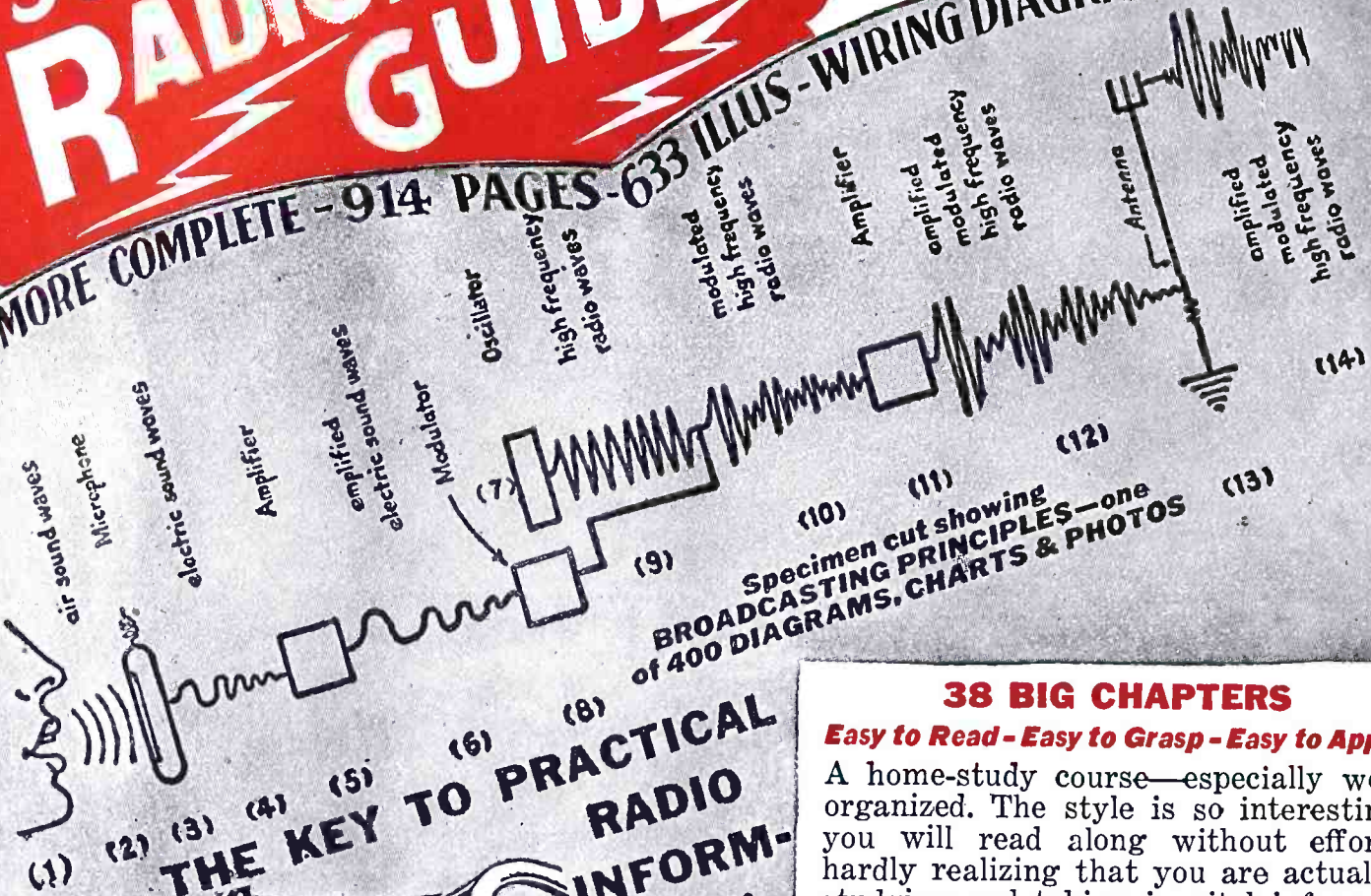

**THE KEY TO PRACTICAL
RADIO
INFORMATION**

It gives you in usable form pointers on radio, including frequency modulation, television, etc. Also valuable inside information for Aviators, Marines, Commercial Operators and Technicians, Servicemen and Students.



**Q AND A
UNIQUE
QUESTION
and
ANSWER
METHOD**

Highly Endorsed

**1001 RADIO FACTS AND FIGURES
A Complete Library In One Book**

AUDELS RADIOMANS GUIDE gives authentic Principles and Practices in Construction, Operation, Service and Repairs. Covers clearly and concisely radio fundamentals—Ohm's Law—Physics of sound as related to radio science—Measuring instruments—Power supply—Resistors—Inductors—Condensers—Transformers and examples—Broadcasting stations—Radio Telephony—Receivers—Diagrams—Construction—Control Systems—Loudspeakers—Antennas—AutoRadio—Phonograph Pick-ups—Public Address Systems—Aircraft and Marine Radio—Radio Compass—Beacons—Automatic Radio Alarms—Short Wave—Coil Calculations—Testing—Cathode Ray Oscillographs—Static Eliminations—Trouble Pointers—Underwriter's standards—Units and tables. **REVIEW QUESTIONS—READY Reference Index.**

38 BIG CHAPTERS

Easy to Read - Easy to Grasp - Easy to Apply

A home-study course—especially well organized. The style is so interesting you will read along without effort, hardly realizing that you are actually studying and taking in vital information. Audels Radiomans Guide gives you just the right amount of mathematics required to cope with radio problems successfully. You can solve, with the aid of this extraordinary book, practically every radio problem that comes up. At your finger tips is a complete index for instant use.



7 DAYS' FREE TRIAL

THEO. AUDEL & CO., Publishers
49 West 23rd Street, New York 10, N. Y.

Mail AUDELS NEW RADIOMANS GUIDE for free examination. If O. K. I will send you \$1 in 7 days; then remit \$1 monthly until \$4 is paid. Otherwise I will return it.

\$4

COMPLETE

\$1

PAY ONLY

MO.

Name
Address
Occupation
Reference

**MAIL THIS
COUPON
TODAY**

RCF

RAYTHEON TUBES RECOMMENDED

FOR POSTWAR

Chris-Craft

Chris-Craft, world's largest maker of speedboats, cruisers and motor yachts, has a line of new streamlined beauties on the drawing boards that are sure to be seen on every lake and river in the peacetime years to come. Their refinements, as compared with prewar models, are almost too numerous to count . . . and one of the most important available accessories is ship-to-shore radio, for which Chris-Craft will recommend famous Raytheon High-Fidelity Tubes.

Radio equipment for marine use must be able to take plenty of battering abuse, and Chris-Craft's recommendation of Raytheon Tubes is based on their splendid wartime performance under the most gruelling battle conditions on land, sea, and in the air.

The moral of this story for you, the radio service dealer, is that Raytheon Tubes, capable of absorbing the punishment of war, are the best bet for giving your customers the dependable, rich reception they rely on you to provide. Their consistent performance . . . plus a post-war Raytheon merchandising program that will revolutionize the radio service industry . . . are the two big reasons why you should feature Raytheon Tubes now!

Increased turnover and profits . . . easier stock control . . . better tubes at lower inventory cost . . . these are benefits which you may enjoy as a result of the Raytheon standardized tube type program, which is part of our continued planning for the future.

Raytheon Manufacturing Company

RADIO RECEIVING TUBE DIVISION

Newton, Mass. • Los Angeles • New York • Chicago • Atlanta



All Four Divisions
Have Been Awarded
Army-Navy "E" With Stars



RAYTHEON

High Fidelity

ELECTRONIC AND RADIO TUBES

Listen to
"MEET YOUR NAVY"
Every Saturday Night
AMERICAN BROADCASTING CO.
Coast to Coast
181 Stations

DEVOTED TO RESEARCH AND THE MANUFACTURE OF TUBES FOR THE NEW ERA OF ELECTRONICS



DETROLA RADIO

DIVISION OF INTERNATIONAL DETROLA CORPORATION

DETROIT 9, MICHIGAN

ADV Plans, LLC

Copyright Notice:

The entire contents of this CD/DVD are copyright 2014 by ADV Plans, LLC. All Rights Reserved.

Reproduction or distribution of this disk, either free or for a fee is strictly prohibited. We actively monitor and remove listings on eBay thru Vero.

You are free to copy or use individual images in your own projects, magazines, brochures or other school projects.

Only the sellers listed here are authorized distributors of this collection:
www.theclassicarchives.com/authorizedsuppliers

Please view our other products at
www.theclassicarchives.com,
or our ebay stores:

[TheClassicArchives](#)
[ADVPlans](#)
[SuperShedPlans](#)

